

***Aspire M3600/M5600***  
***AcerPower M461/S461***  
***Service Guide***

Service guide files and updates are available on the AIPG/CSD web; for more information, please refer to <http://csd.acer.com.tw>

PRINTED IN TAIWAN

---

# Revision History

Please refer to the table below for the updates made on Aspire M3600/M5600 and AcerPower M461/S461 service guide.

Date	Chapter	Updates

---

## ***Copyright***

Copyright © 2006 by Acer Incorporated. All rights reserved. No part of this publication may be reproduced, transmitted, transcribed, stored in a retrieval system, or translated into any language or computer language, in any form or by any means, electronic, mechanical, magnetic, optical, chemical, manual or otherwise, without the prior written permission of Acer Incorporated.

## ***Disclaimer***

The information in this guide is subject to change without notice.

Acer Incorporated makes no representations or warranties, either expressed or implied, with respect to the contents hereof and specifically disclaims any warranties of merchantability or fitness for any particular purpose. Any Acer Incorporated software described in this manual is sold or licensed "as is". Should the programs prove defective following their purchase, the buyer (and not Acer Incorporated, its distributor, or its dealer) assumes the entire cost of all necessary servicing, repair, and any incidental or consequential damages resulting from any defect in the software.

Acer is a registered trademark of Acer Corporation.

Intel is a registered trademark of Intel Corporation.

Pentium 4 and Celeron are trademarks of Intel Corporation.

Other brand and product names are trademarks and/or registered trademarks of their respective holders.

---

## ***Conventions***

The following conventions are used in this manual:

<b>SCREEN MESSAGES</b>	Denotes actual messages that appear on screen.
<b>NOTE</b>	Gives bits and pieces of additional information related to the current topic.
<b>WARNING</b>	Alerts you to any damage that might result from doing or not doing specific actions.
<b>CAUTION</b>	Gives precautionary measures to avoid possible hardware or software problems.
<b>IMPORTANT</b>	Reminds you to do specific actions relevant to the accomplishment of procedures.

---

## ***Preface***

Before using this information and the product it supports, please read the following general information.

1. This Service Guide provides you with all technical information relating to the BASIC CONFIGURATION decided for Acer's "global" product offering. To better fit local market requirements and enhance product competitiveness, your regional office MAY have decided to extend the functionality of a machine (e.g. add-on card, modem, or extra memory capability). These LOCALIZED FEATURES will NOT be covered in this generic service guide. In such cases, please contact your regional offices or the responsible personnel/channel to provide you with further technical details.
2. Please note WHEN ORDERING FRU PARTS, that you should check the most up-to-date information available on your regional web or channel. If, for whatever reason, a part number change is made, it will not be noted in the printed Service Guide. For ACER-AUTHORIZED SERVICE PROVIDERS, your Acer office may have a DIFFERENT part number code to those given in the FRU list of this printed Service Guide. You MUST use the list provided by your regional Acer office to order FRU parts for repair and service of customer machines.



---

## Chapter 1 **System Specifications 1**

- Features 1
- Mainboard Placement 4
- Block Diagram 6
- Aspire M3600/M5600 Front Panel 7
- Aspire M3600/M5600 Rear Panel 9
- AcerPower M461 Front Panel 10
- AcerPower M461 Rear Panel 11
- System Peripherals 12
- Acer eRecovery 14
- Acer disc-to-disc recovery 16
- Hardware Specifications and Configurations 17
- Power Management Function (ACPI support function) 22

## Chapter 2 **System Utilities 23**

- About the Setup Utility 23
- Product Information 25
- Standard CMOS Features 26
- Advanced BIOS Features 28
- Advanced Chipset Features 31
- Integrated Peripherals 33
- Power Management Setup 36
- PnP/PCI Configurations 38
- PC Health Status 39
- Frequency Control 40

## Chapter 3 **Machine Disassembly and Replacement 42**

- General Information 43
- Disassembly Procedure 44

## Chapter 4 **Troubleshooting 57**

## Chapter 5 **Jumper and Connector Information 58**

- Main Board Placement 58
- Jumper Setting 60

## Chapter 6 **FRU (Field Replaceable Unit) List 67**

- Exploded Diagram 68
- FRU List 69





# ***System Specifications***

---

## ***Features***

### ***Processor***

- Socket Type : Intel Socket T LGA 775 pin
- Processor Type : Intel Conroe FSB 800/1066 MHz

### ***Chipset***

- Intel 946GZ+ICH7DH

### ***PCB***

- Form Factor : Mirco ATX
- Size (Max.) : 244mm x 244mm

### ***Memory***

- Memory Type : DDRII 1.8V unbuffered SDRAM module support
- No. of Channel (Dual/Signal) : Dual channel should be enabled always when plug-in 2 same memory size DDRII memory module
- Socket Type : un-buffered 240 pin DIMM socket
- DIMM Slot : 2

### ***Graphics***

- Onboard graphic solution: Intel 946GZ(Intel GMA X3000) integrated graphics device solution
- Dual View function support(by Intel ADD2/ADD2+)
- One D-sub VGA port on rear

### ***PCI***

- One PCI Express x16 slot
- One PCI Express x1 slot
- Two PCI 2.3 Slots

### ***FDD***

- Slot Quantity : 1
- Support 1.44MB 3.5" Devices

### ***SATA***

- 4 pin SATA IDE connector
  - Transfer rate support:
    - 1.5GB/s and 3.0 GB/s
  - Storage type support : HDD/CD-ROM/DVD-ROM/DVD-RW/DVD+RW/DVD Dual/DVD SuperMultiPlus

---

## ***Audio***

- Audio Type : HD Codec
- Audio Channel : 7.1 channel
- Audio Controller /Codec : Realtek ALC888
- Support SPDIF out
- Audio Connectors/Headers:
  - Rear 6 jack follow HD audio definition
  - Microphone In
  - Headphone Out
  - S/PDIF out header
  - Support front panel audio header
  - Add HD de-pop CKT
  - AUX-In

## ***LAN***

- Type : Intel 82573L (Vidalia) PCI-E Giga LAN
- Supports 10/100/1000MB Ethernet environment

## ***IEEE 1394***

- IEEE 1394 Controller : TI TSB43AB23PDTG4
- IEEE 1394 Port : One rear 6pin IEEE 1394 port
- One header on board

## ***USB***

- Controller : Intel ICH7DH
- USB Type : 2.0/1.1
- Connectors Quantity: 8
  - Real Panel : 4
  - Onboard header: 2 ports for front daughter board, 2 ports for card reader+IR
- Standard Intel FPIO pin definition

## ***BIOS***

- BIOS Type : Phoenix-Award BIOS
- 4MB Flash BIOS
- Award PnP BIOS compatible with SM BIOS 2.3
- ACPI, SMBIOS 2.3, Green and Boot Block.
- Provides DMI 2.0, WFM 2.0, WOL, and SM Bus for system management.

---

## ***I/O Connector***

- Controller : Super I/O ITE 8718

## ***Rear I/O Connector***

- 1 PS/2 Keyboard Port, 1 PS/2 Mouse Port
- 1 Parallel Port, 1 Serial Port
- 1 D-sub VGA Port
- 1 LAN Port
- 4 USB Ports
- 7.1 channel phone jack
- 1 6 pin 1394 port

## ***Onboard Connector***

- 1 CPU socket
- 2 Memory slots
- 1 PCI Express x16 slot
- 1 PCI Express x1 slot
- 2 PCI slots
- 1 FDD connector
- 1 IDE slot
- 4 SATA2 IDE connectors
- 3 2\*5 pin Intel FPIO specification USB pin connectors.
- 1 2\*5 pin Intel FPIO spec. microphone in/headphone out connector
- 1 2\*5 pin serial port connector
- 1 CD-IN 4pin connector (CD-ROM Audio Input)
- 1 S/PDIF out 4pin jumper
- 1 4pin CPU Fan connector
- 1 3pin system fan connector with 3pin system fan co-lay
- 1 24pin ATX interface PS3/PS2 SPS connector
- 1 2\*7 pin front panel IO header
- one 2pin OBR header
- 1 onboard buzzer
- 1 1394 header
- Color management for on board connector

## ***Power Supply***

- PSP Type : 250W

# Mainboard Placement

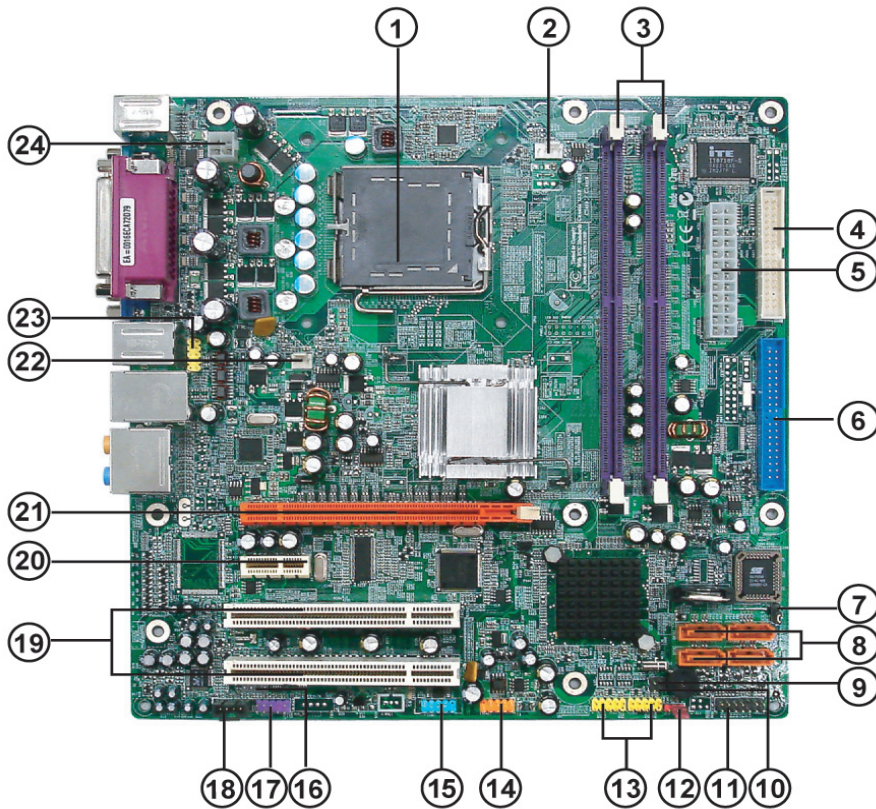

No.	Name	Description
1	CPU Socket	LGA775 socket for Intel Core™2 Duo/Pentium D/Pentium 4/Celeron D CPUs
2	CPU_FAN1	CPU cooling fan connector
3	DIMM1~2	DDR2 240 pin SDRAM slots
4	FDD1	Floppy diskette drive connector
5	ATX1	Standard 24pin ATX power connector
6	IDE1	Primary IDE channel
7	BIOS_WP	BIOS flash protect jumper
8	SATA1~4	Serial ATA connectors
9	JP2	Jumper
10	JP1	Jumper
11	PANEL1	Front panel switch/LED header
12	CLR_CMOS1	Clear CMOS jumper
13	USB3~4	Front panel USB headers
14	1394A1	Onboard 1394a header
15	COM2	Onboard Serial port header
16	SPDIF	SPDIF out header
17	AUDIO2	Front Panel Audio header

---

No.	Name	Description
18	CD_IN1	Analog audio input connector
19	PCI1~2	32 bit add-on card slot
20	PCIEX1	PCI Express x1 slot
21	PCIEX16	PCI Express x16 slot
22	SYS_FAN1	System fan connector
23	R_USB	Front Panel USB header
24	ATX12V1	Auxiliary 4pin power connector

# Block Diagram

DEVICE	IDSEL	INT#	REQ#	GRNT#
PCI1	17	C/D/E/F	REQ-0	GRNT-0
PCI2	18	D/E/F/G	REQ-1	GRNT-1
1394	19	E	REQ-2	GRNT-2

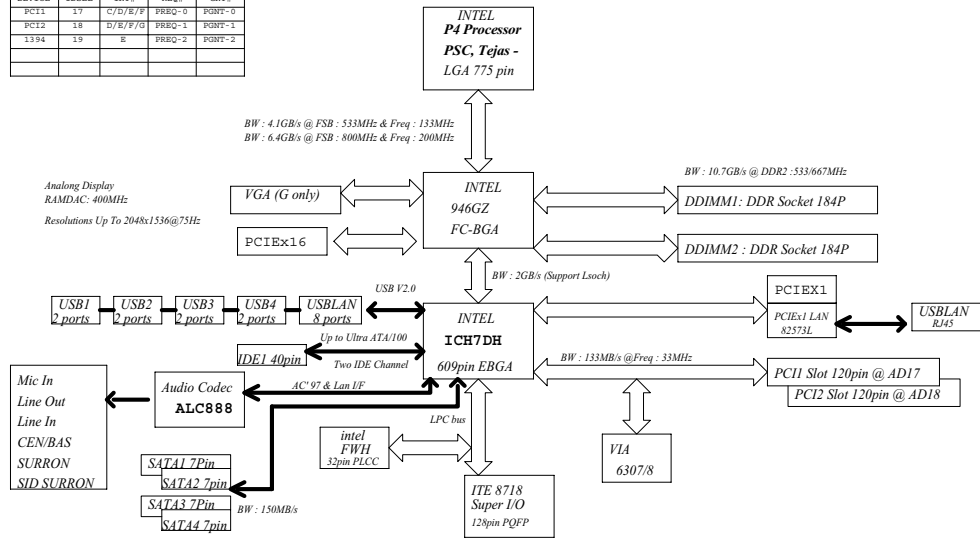

PCB : 244 x 244 mm ; 4 layers

# Aspire M3600/M5600 Front Panel

The computer's front panel consists of the following:

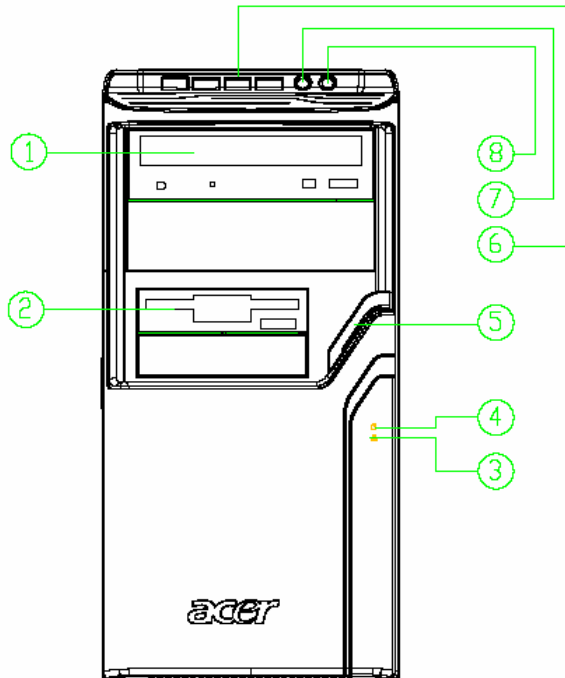
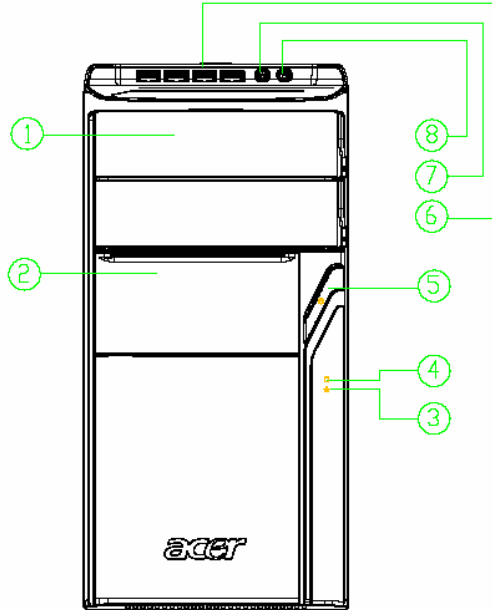

Label	Description
1	Optical drive
2	Slide door/ Floppy disk drive

---

<b>Label</b>	<b>Description</b>
3	LAN LED
4	HDD LED
5	Power Button
6	USB ports
7	MIC phone
8	Speaker out



# Aspire M3600/M5600 Rear Panel

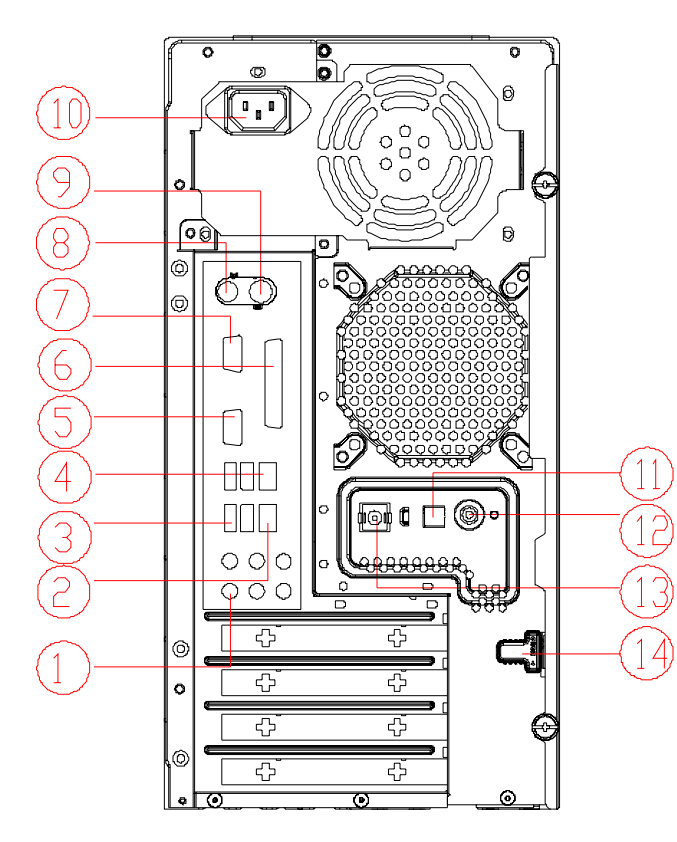

No.	Description	No.	Description
1	6 audio jacks	2	LAN port
3	USB ports	4	1394 port
5	CRT/LCD port	6	Parallel port
7	HDMI port	8	PS/2 keyboard connector
9	PS/2 mouse connector	10	Power cord port
11	SPDIF bracket	12	SPDIF port
13	Recovery switch holder	14	Lock handle

# AcerPower M461 Front Panel

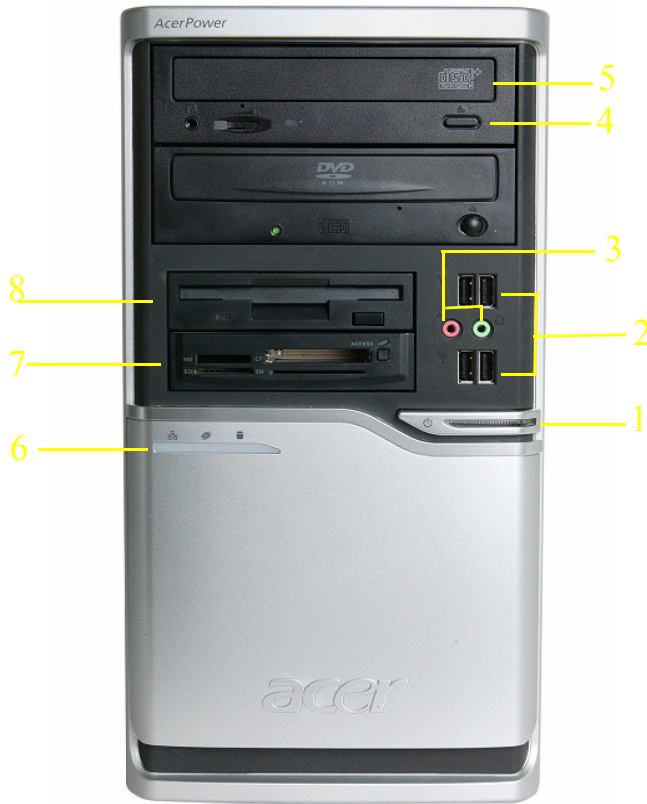

Label	Description
1	Power-Button
2	USB ports
3	Microphone-in & Speaker-out/Line-out Port
4	Optical drive eject button
5	Optical drive
6	Indicators
7	Card reader
8	HDD

# AcerPower M461 Rear Panel

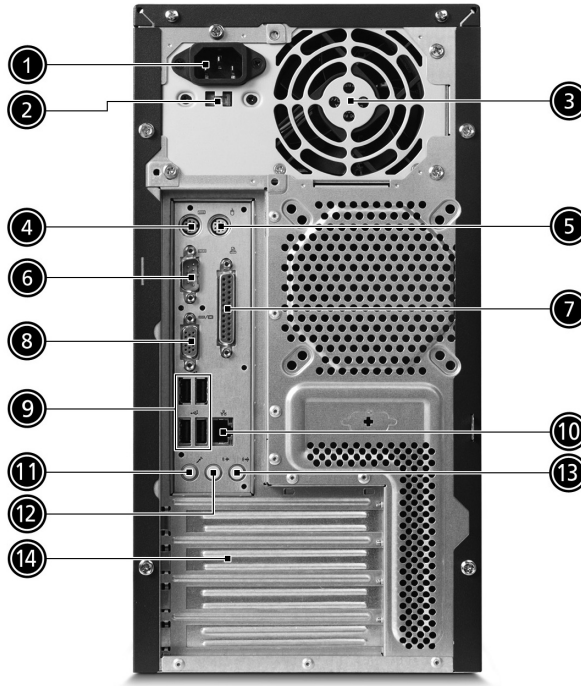

No.	Description	No.	Description
1	Power cord socket	2	Voltage selector switch
3	Fan aperture	4	PS/2 keyboard connector
5	PS/2 mouse connector	6	Serial port
7	Printer connector	8	Monitor connector
9	USB 2.0 ports	10	RJ-45 Ethernet connector
11	Microphone jack	12	Line-out Jack
13	Line-in jack	14	Extension card slots

---

## ***System Peripherals***

The Aspire S Series computer consist of the system itself, and system peripherals, like a mouse, keyboard and a set of speakers (optional). This section provides a brief description of the basic system peripherals.

### ***Mouse (PS/2 or USB, manufacturing option)***

The included mouse is a standard two-button wheel mouse. Connect the mouse to the PS/2 mouse port or USB port on the back panel of the system.



### ***Keyboard (PS/2 or USB, manufacturing option)***

Connect the keyboard to the PS/2 keyboard port or USB port on the back panel of the system.



---

## ***Speakers***

For systems bundled with speakers, before powering on the system, connect the speaker cable to the audio out (external speaker) port on the back panel of the system.

For more detailed information about the speakers, please refer to the included operating instructions.

**NOTE:** speakers are optional and the appearance might be different depending on the actual product.



---

## ***Acer eRecovery***

Acer eRecovery is a tool to quickly backup and restore the system. Users can create and save a backup of the current system configuration to hard drive, CD, or DVD.

Acer eRecovery consists of the following functions:

1. Create backup
2. Restore from backup
3. Create factory default image CD
4. Re-install bundled software without CD
5. Change Acer eRecovery password

### ***Create backup***

Users can create and save backup images to hard drive, CD, or DVD.

1. Boot to Windows XP
2. Press **<Alt>+<F10>** to open the Acer eRecovery utility.
3. Enter the password to proceed. The default password is six zeros.
4. In the Acer eRecovery window, select **Recovery settings** and click **Next**
5. In the Recovery settings window, select **Backup snapshot image** and click **Next**.
6. Select the backup method.
  - Use **Backup to HDD** to store the backup disc image on drive D:.
  - Backup to optical device** to store the backup disc image on CD or DVD (only available on systems that include an optical disc burner).
7. After choosing the backup method, click **Next**.

Follow the instruction on screen to complete the process.

### ***Restore from backup***

Users can restore backup previously created (as stated in the **Create backup** section) from hard drive, CD, or DVD.

1. Boot to Windows XP.
2. Press **<Alt>+<F10>** to open the Acer eRecovery utility.
3. Enter the password to proceed. The default password is six zeros.
4. In the Acer eRecovery window, select **Recovery actions** and click **Next**.
5. Select the desired restore action and follow the onscreen instructions to complete the restore process.

### ***Create factory default image CD***

When the System CD and Recovery CD are not available, you can create them by using this feature.

1. Boot to Windows XP.
2. Press **<Alt>+<F10>** to open the Acer eRecovery utility.
3. Enter the password to proceed. The default password is six zeros.
4. In the Acer eRecovery window, select **Recovery settings** and click **Next**.
5. In the Recovery settings window, select **Burn image to disc** and click **Next**.
6. In the Burn image to disc window, select **01. Factory default image** and click **Next**.

- 
7. Follow the instructions on screen to complete the process.

### ***Re-install bundled software without CD***

Acer eRecovery stores pre-loaded software internally for easy driver and application re-installation.

1. Boot to Windows XP.
2. Press <Alt>+<F10> to open the Acer eRecovery utility.
3. Enter the password to proceed. The default password is six zeros.
4. In the Acer eRecovery window, select Recovery actions and click **Next**.
5. In the Recovery settings window, select **Reinstall applications/drivers** and click **Next**.
6. Select the desired driver/application and follow the instructions on screen to re-install.

At first launch, Acer eRecovery prepares all the needed software and may take few seconds to bring up the software content window.

### ***Change Password***

Acer eRecovery and Acer disc-to-disc recovery are protected by a password that can be changed by the user. Follow the steps below to change the password in Acer eRecovery.

1. Boot to Windows XP.
2. Press <Alt>+<F10> to open the Acer eRecovery utility.
3. Enter the password to proceed. The default password is six zeros.
4. In the Acer eRecovery window, select **Recovery settings** and click **Next**.
5. In the Recovery settings window, select **Password: Change Acer eRecovery password** and click **Next**.
6. Follow the instructions on screen to complete the process.

---

## ***Acer disc-to-disc recovery***

### ***Restore without a Recovery CD***

This recovery process helps you restore the C: drive with the original software content that is installed when you purchase your notebook. Follow the steps below to rebuild your C: drive. (Your C: drive will be reformatted and all data will be erased.) It is important to back up all data files before you use this option.

1. Restart the system.
2. While the Acer logo is showing, press <Alt>+<F10> at the same time to enter the recovery process.
3. The message "The system has password protection. Please enter 000000:" is displayed.
4. Enter six zeros and continue.
5. The Acer Recovery main page appears.
6. Use the arrow keys to scroll through the items (operating system versions) and press <Enter> to select.

### ***Multilingual operating system installation***

Follow the instructions to choose the operating system and language you prefer when you first power-on the system.

1. Turn on the system.
2. Acer's multilingual operating system selection menu will pop-up automatically.
3. Use the arrow keys to scroll to the language version you want. Press <Enter> to confirm your selection.
4. The operating system and language you choose now will be the only option for future recovery operations.
5. The system will install the operating system and language you choose.



---

# Hardware Specifications and Configurations

## Processor

Item	Specification
Type	Intel Prescott 775/Conroe
Socket	Socket T LGA 775 pin
Speed	System bus total up to 20.8GB/s
FSB	800/1600 MHz

## BIOS

Item	Specification
BIOS code programmer	Award
BIOS version	v6.0
BIOS ROM type	Flash ROM
BIOS ROM size	4MB
BIOS ROM package	32-pin DIP package
Support protocol	ACPI 2.0, APM 1.2, SMBIOS 2.3, WFM support, ASD 1.03, PXE boot ROM, PCI 2.3
Boot from CD-ROM feature	Yes
Support to LS-120 FDD drive	Yes
Support to BIOS boot block feature	Yes

**NOTE:** The BIOS can be overwritten/upgraded by using the flash utility.

## BIOS Hotkey List

Hotkey	Function	Description
Delete	Enter BIOS Setup Utility	Press while the system is booting to enter BIOS Setup Utility.

## Main Board Major Chips

Item	Controller
NorthBridge	Intel 946GZ
SourthBridge	Intel ICH7DH
AGP controller	Intel 946GZ
Super I/O controller	ITE8718
Audio controller	ALC888
LAN controller	Intel 82573L
HDD controller	ICH7DH
Keyboard controller	ITE8718

### ***System Memory***

<b>Item</b>	<b>Specification</b>
Memory slot number	2 slot
Support memory size per socket	256MB to 1GB
Support maximum memory size	2GB
Support memory type	DDR2 SDRAM
Support memory interface	DDR2 667/533
Support memory voltage	1.8V
Support memory module package	240-pin DIMM
Support to parity check feature	Yes
Support to Error Correction Code (ECC) feature	ECC checking with double-bit detect and single-bit correct
Memory module combinations	You can install memory modules in any combination as long as they match the specifications.

**NOTE:** Dual channel should be enabled always when plug-in 2 same memory size DDRII memory module.

### ***Cache Memory***

<b>Item</b>	<b>Specification</b>
<b>First-Level Cache Configurations</b>	
Cache function control	Enable/Disable by BIOS Setup
<b>Second-Level Cache Configurations</b>	
L2 Cache RAM type	PBSRAM
L2 Cache RAM size	up to 1MB per core(exclusive)
L2 Cache RAM speed	One-half the processor core clock frequency
L2 Cache function control	Enable/Disable by BIOS Setup
L2 Cache scheme	Fixed in write-back

### ***Video Interface***

<b>Item</b>	<b>Specification</b>
Video controller	Intel ICH7DH
Video controller resident bus	PCIe
Video Interface	x16
AGP Slot	1

### ***Audio Interface***

<b>Item</b>	<b>Specification</b>
Audio controller	ICH7DH
Audio controller Type	AC'97, ALC888
Audio Channel	7.1ch
Audio function control	Enable/disable by BIOS Setup

### ***Audio Interface***

<b>Item</b>	<b>Specification</b>
Mono or stereo	Stereo
Resolution	support up to 24 bit
Compatibility	Sound Blaster Pro/16 compatible Mixed digital and analog high performance chip Enhanced stereo full duplex operation High performance audio accelerator and AC'97 support Full native DOS games compatibility Virtual FM enhances audio experience through real-time FM-to-Wavetable conversion MPU-401(UART mode) interface for wavetable synthesizers and MIDI devices Integrated dual game port Meets AC'97and WHQL specifications
Music synthesizer	Yes, internal FM synthesizer
Sampling rate	DACs: 44.1k/48k/96k/192k Hz ADCs: 44.1k/48k/96k Hz
MPU-401 UART support	Yes
Microphone jack	Supported
Headphone jack	Supported

### ***IDE Interface***

<b>Item</b>	<b>Specification</b>
IDE controller	Intel ICH7DH
IDE controller resident bus	PCI bus
Number of IDE channel	1
Support IDE interface	E-IDE (up to PIO mode-4 and Ultra DMA 33/66/100/133), ANSIS ATA rev.3.0 ATAPI
Support bootable CD-ROM	Yes

### ***Floppy disk drive Interface***

<b>Item</b>	<b>Specification</b>
Floppy disk drive controller	ITE8718
Floppy disk drive controller resident bus	LPC bus
Support FDD format	should support 1.44MB/3mode 3.5" Devices

### ***Parallel Port***

<b>Item</b>	<b>Specification</b>
Parallel port controller	ITE8718
Parallel port controller resident bus	ISA bus
Number of parallel ports	1
Support ECP/EPP	Bi-directional SPP / ECP / EPP V1.7&V1.9
Connector type	25-pin D-type female connector
Parallel port function control	Enable/disable by BIOS Setup

### ***Serial Port***

<b>Item</b>	<b>Specification</b>
Serial port controller	ITE8718
Serial port controller resident bus	ISA bus
Number of serial port	2
16550 UART support	Yes
Connector type	9-pin D-type female connector
Features	Support IrDA1.0/ASKIR protocols, smart card reader protocols

### ***USB Port***

<b>Item</b>	<b>Specification</b>
Universal HCI	USB 2.0
USB Class	Support legacy keyboard for legacy mode
USB Number	support up to 8 ports

### ***Environmental Requirements***

<b>Item</b>	<b>Specifications</b>
Temperature	
Operating	+5°C ~ +35°C
Non-operating	-20 ~ +60°C (Storage package)
Humidity	
Operating	15% to 80% RH
Non-operating	10% to 90% RH
Vibration	
Operating (unpacked)	5 ~ 500 Hz: 2.20g RMS random, 10 minutes per axis in all 3 axes 5 ~ 500 Hz: 1.09g RMS random, 1 hour per axis in all 3 axes

### ***Power Management***

<b>Devices</b>	<b>S1 (Idle)</b>	<b>S3 (Suspend to RAM)</b>	<b>S4 (Suspend to Disk)</b>	<b>S5 (Shut Down)</b>
Power Button	Enabled	Enabled	Enabled	Disabled

---

**Power Management**

<b>Devices</b>	<b>S1 (Idle)</b>	<b>S3 (Suspend to RAM)</b>	<b>S4 (Suspend to Disk)</b>	<b>S5 (Shut Down)</b>
USB Keyboard	Enabled	Enabled	Disabled	N/A
LAN	Disabled	Disabled	Disabled	Disabled
RTC	Disabled	Enabled	Disabled	Disabled
Modem (Ring)	Disabled	Disabled	Disabled	N/A

---

## ***Power Management Function (ACPI support function)***

### ***Device Standby Mode***

- Independent power management timer for hard disk drive devices (0-15 minutes, time step=1 minute).
- Hard disk drive goes into Standby mode (for ATA standard interface).
- Disable V-sync to control the VESA DPMS monitor.
- Resume method: device activated (Keyboard for DOS, keyboard & mouse for Windows).
- Resume recovery time: 3-5 sec.

### ***Global Standby Mode***

- Global power management timer (2-120 minutes, time step=10 minute).
- Hard disk drive goes into Standby mode (for ATA standard interface).
- Disable H-sync and V-sync signals to control the VESA DPMS monitor.
- Resume method: Return to original state by pushing external switch button, modem ring in, keyboard and mouse for APM mode.
- Resume recovery time: 7-10 sec.

### ***Suspend Mode***

- Independent power management timer (2-120 minutes, time step=10 minutes) or pushing external switch button.
- CPU goes into SMM.
- CPU asserts STPCLK# and goes into the Stop Grant State.
- LED on the panel turns amber colour.
- Hard disk drive goes into SLEEP mode (for ATA standard interface).
- Disable H-sync and V-sync signals to control the VESA DPMS monitor.
- Ultra I/O and VGA chip go into power saving mode.
- Resume method: Return to original state by pushing external switch button, modem ring in, keyboard and mouse for APM mode.
- Return to original state by pushing external switch button, modem ring in and USB keyboard for ACPI mode.

### ***ACPI***

- ACPI specification 1.0b.
- S0, S1, S3 and S5 sleep state support.
- On board device power management support.
- On board device configuration support.

## ***System Utilities***

---

### ***About the Setup Utility***

The computer uses the latest Award BIOS with support for Windows Plug and Play. The CMOS chip on the main board contains the ROM setup instructions for configuring the main board BIOS.

The BIOS Setup Utility displays the system's configuration status and provides you with options to set system parameters. The parameters are stored in battery-backed-up CMOS RAM that saves this information when the power is turned off. When the system is turned back on, the system is configured with the values you stored in CMOS.

The BIOS Setup Utility enables you to configure:

- Hard drives, diskette drives and peripheral
- Video display type and display options
- Password protection from unauthorized use
- Power Management features

The settings made in the Setup Utility affect how the computer performs. Before using the Setup Utility, ensure that you understand the Setup Utility options.

### ***The Standard Configuration***

A standard configuration has already been set in the Setup Utility. However, we recommend that you read this chapter in case you need to make any changes in the future.

This Setup Utility should be used:

- when changing the system configuration
- when a configuration error is detected and you are prompted to make changes to the Setup Utility
- when trying to resolve IRQ conflicts
- when making changes to the Power Management configuration

---

## Entering the Setup Utility

When you power on the system, BIOS enters the Power-On Self-Test (POST) routines. POST is a series of built-in diagnostics performed by the BIOS. After the POST routines are completed, the following message appears: Press DEL to enter SETUP

Press the delete key to have access to the BIOS Setup Utility.

**NOTE:** If the message disappears before you respond and you still want to enter Setup, restart the system by turning it OFF and On. You may also restart the system by simultaneously pressing [Ctrl + Alt + Delete].

▶ Product Information	▶ PC Health Status
▶ Standard CMOS Features	▶ Frequency/Voltage Control
▶ Advanced BIOS Features	Load Optimized Defaults
▶ Advanced Chipset Features	Set Supervisor Password
▶ Integrated Peripherals	Set User Password
▶ Power Management Setup	Save & Exit Setup
▶ PnP/PCI Configurations	Exit Without Saving
Esc: Quit	↑ ↓ → ← : Select Item
F10: Save & Exit Setup	
Time, Date, Hard Disk Type...	

## BIOS Navigation Keys

The BIOS navigation keys are listed below:

- ESC:** Exits the current menu.
- ↑ ↓ → ←:** Scrolls through the items on a menu.
- +/-/PU/PD:** Modifies the selected field's values.
- F10:** Saves the current configuration and exits setup.
- F1:** Displays a screen that describes all key functions.
- F5:** Loads previously saved values to CMOS.
- F7:** Loads an optimum set of values for peak performance.

## Using BIOS

When you start the Setup Utility, the main menu will appear. The main menu of the Setup Utility displays a list of the options that are available. A highlight indicates which option is currently selected. Use the cursor arrow keys to move the highlight to other options. When an option is highlighted, execute the option by pressing <Enter>.

Some options lead to pop-up dialog box that prompt you to verify that you want to execute that option. Other options lead to dialog boxes that prompt you for information.

Some options (marked with a triangle) lead to submenus that enable you to change the values for that option. Use the cursor arrow keys to scroll through the items in the submenu.

In this chapter, default values are enclosed in parenthesis. Submenu items are denoted by a triangle.



## Product Information

This option displays basic information about the system.

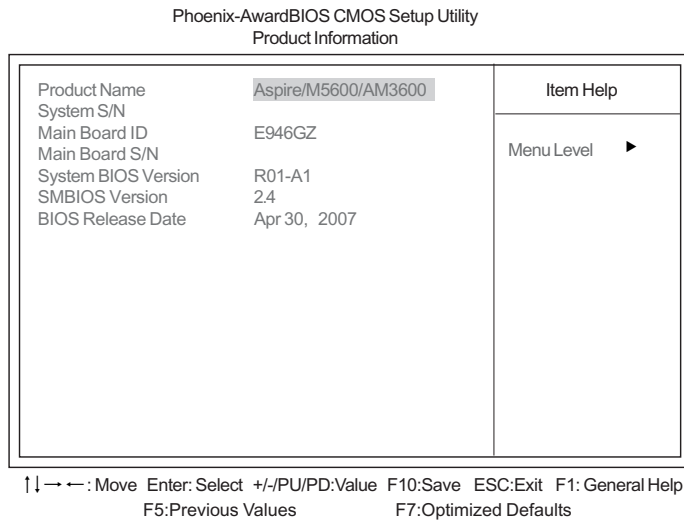

- Product Names:** Displays the model name of your system.
- System S/N:** Displays your system's serial number.
- Main Board ID:** Displays the ID number of the main board.
- Main Board S/N:** Displays the serial number of the main board.
- System BIOS Version:** Specifies the version of the BIOS utility.
- SMBIOS Version:** The System Management Interface (SM) BIOS allows you to check your system hardware components without actually opening your system. Hardware checking is done via software during start up. This parameter specifies the version of the SMBIOS utility installed in your system.
- BIOS Release Date:** Displays the BIOS latest release date.

## Standard CMOS Features

Select Standard CMOS Features from the main menu to configure some basic parameters in your system.

### Phoenix-AwardBIOS CMOS Setup Utility Standard CMOS Features

Date (mm:dd:yy)	Sun, Jan 1 2006	Item Help
Time (hh:mm:ss)	9 : 33 : 26	
▶ IDE Channel 0 Master	[ None]	Menu Level ▶
▶ IDE Channel 0 Slave	[LITE-ON DVD SOHD-16F]	Change the day, month, year and century
▶ IDE Channel 1 Master	[ None]	
▶ IDE Channel 1 Slave	[ None]	
▶ IDE Channel 2 Master	[ST3160612AS]	
▶ IDE Channel 2 Slave	[ None]	
▶ IDE Channel 3 Master	[ None]	
▶ IDE Channel 3 Slave	[ None]	
Video	[EGA/VGA]	
Halt On	[All , But Keyboard]	
Base Memory	640K	
Extended Memory	65535K	
Total Memory	1024K	

↑↓ → ← : Move Enter: Select +/-/PU/PD:Value F10:Save ESC:Exit F1: General Help  
F5:Previous Values F7:Optimized Defaults

- ❑ **Date and Time:** This item shows the current date and time set on the computer. If you are running a Windows OS, these items are automatically updated whenever you make changes to the Windows Date and Time Properties utility.
- ❑ **IDE Devices (none):** Your computer has one IDE channel and can be installed with one or two devices (Master and Slave). Use this item to configure each device on the IDE channel. This main board features four SATA connectors supporting four SATA drives. SATA refers to Serial ATA (Advanced Technology Attachment), the standard interface for the IDE hard drives which are currently used in most PCs.

### Phoenix-AwardBIOS CMOS Setup Utility IDE Channel 0 Maser

IDE HDD Auto-Detection	[Press Enter]	Item Help
IDE Channel 0 Master Access Mode	[Auto] [Auto]	Menu Level ▶▶
Capacity	0 MB	To auto-detect the HDD's size, head... on this channel
Cylinder	0	
Head	0	
Precomp	0	
Landing Zone	0	
Sector	0	

↑↓ → ← : Move Enter: Select +/-/PU/PD:Value F10:Save ESC:Exit F1: General Help  
F5:Previous Values F7:Optimized Defaults

- 
- IDE HDD Auto-Detection:** Press <Enter> while this item is highlighted to prompt the Setup Utility to automatically detect and configure an IDE device on the IDE channel.

**NOTE:** Press <Enter> while this item is highlighted to prompt the Setup Utility to automatically detect and configure an IDE device on the IDE channel.

- IDE Channel 0/1/2/3 Master/Slave IDE/Extended IDE Drives (Auto):** Leave this item Auto to enable the system to automatically detect and configure IDE devices on the channel. If it fails to find a device, change the value to Manual and then manually configure the drive by entering the properties of the drive in the items described below. Please note that if you choose IDE channel 2/3 Master, the item may change to Extended IDE drive.
- Access Mode:** This item defines ways that can be used to access IDE hard disks such as LBA (Large Blocking Addressing). Leave this value Auto and the system will automatically decide the fastest way to access the hard disk drive. If you choose IDE channel 2/3 Master, the item only has Large and Auto.
- Video (EGA/VGA):** This item defines the video mode of the system. This main board has a built-in VGA graphics system. You must leave this item at the default value.
- Halt On (All but Keyboard):** This item defines the operation of the system POST (Power-On Self-Test) routine. You can use this item to select which types of errors in the POST are sufficient to halt the system.
- Base Memory, Extended Memory, and Total Memory:** These items are automatically detected by the system at start up time. These are display-only fields. You can not make changes to these fields.

# Advanced BIOS Features

The following screen shows the Advanced BIOS Features.

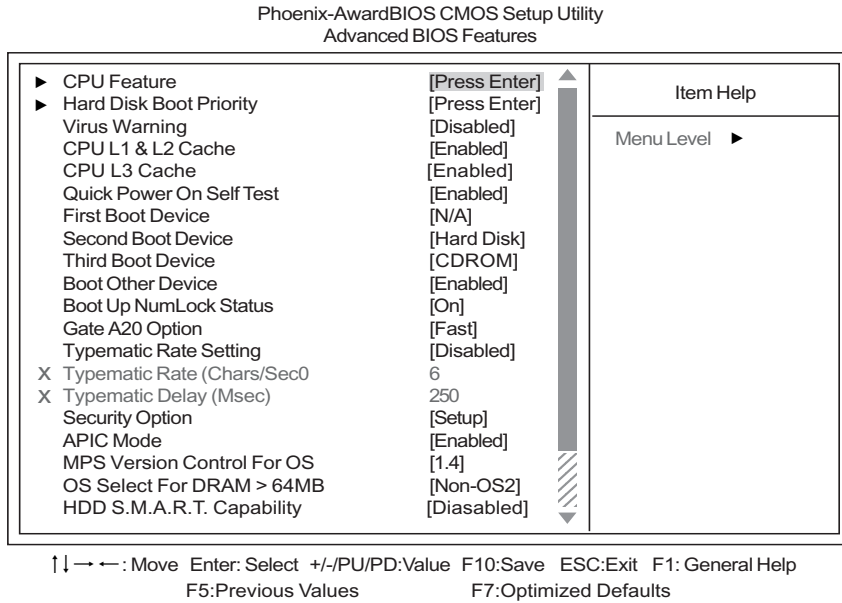

- ❑ **CPU Features (Press Enter):** Please note that this function is only available for Prescott CPUs. Scroll to this item and press <Enter> to view the following screen.

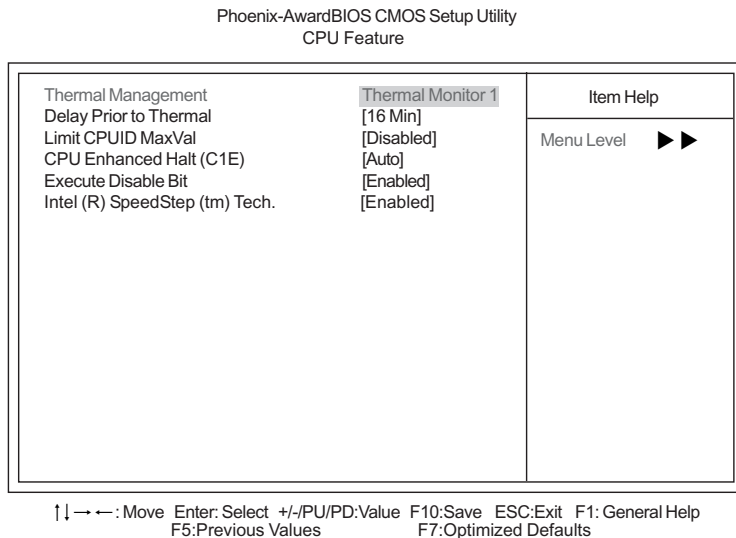

- ❑ **Delay Prior to Thermal (16 Min):** This item enables you to set the delay time before the CPU

enters auto thermal mode.

- Thermal Management (Thermal Monitor 1):** This item displays CPU's temperature and enables you to set a safe temperature to Prescott CPU.
- TM2 Bus Ratio (12X):** This item represents the frequency (bus ratio) of the throttled performance state that will be initiated when the on-die sensor goes from not hot to hot.
- TMS Bus VID (1.2000V):** This item represents the voltage of the throttled performance state that will be initiated when the on-die sensor goes from not hot to hot.
- Limit CPUID MaxVal (Disabled):** This item can support Prescott CPUs for old OS. Please note that under NT4.0, it must be set **Enabled** while under WinXP, it must be set **Disabled**.
- Execute Disable Bit (Enabled):** This item is a security feature that helps you protect your CPU and operating system against malicious software executing code. This item is available when CPU supports the feature.
- Hard Disk Boot Priority (Press Enter):** Scroll to this item and press <Enter> to view the following screen.

Phoenix-AwardBIOS CMOS Setup Utility  
Hard Disk Boot Priority

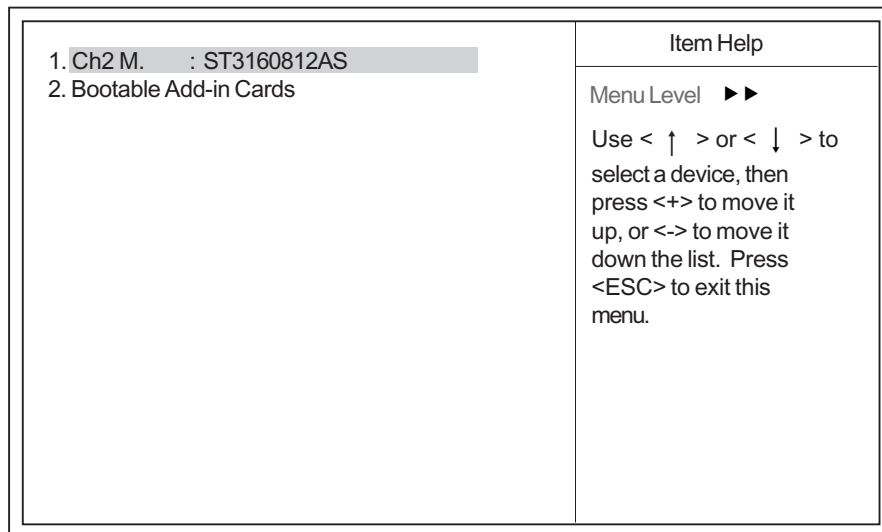

- Virus Warning (Disabled):** This item is used to enable or disable virus warning function.
- CPU L1 & L2 Cache (Enabled):** All processors that can be installed in this main board use internal level 1 (L1) and external level 2 (L2) cache memory to improve performance. Leave this item at the default value for better performance.
- Hyper-Threading Technology (Enabled):** This item is only available when the chipset supports Hyper-Threading and you are using a Hyper-Threading CPU.
- Quick Power On Self Test (Enabled):** Enable this item to shorten the power on testing (POST) and have your system start up faster. You might like to enable this item after you are confident that your system hardware is operating smoothly.
- First/Second/Third Boot Device (Floppy/Hard Disk/CD ROM):** Use these three items to select the priority and order of the devices that your system searches for an operating system at start-up time.
- Boot Other Device (Enabled):** When enabled, the system searches all other possible locations for an operating system if it fails to find one in the devices specified under the First, Second and Third boot devices.

- 
- Boot Up NumLock Status (On):** This item defines if the keyboard NumLock key is active when your system is started.
  - Gate A20 Option (Fast):** This item defined how the system handles legacy software that was written for an earlier generation of processors. Leave this item at the default value.
  - Typematic Rate Setting (Disabled):** If this item is enabled, you can use the following two items to set the typematic rate and the typematic delay settings for your keyboard.
    - Typematic Rate (Chars/Sec):** Use this item to define how many characters per second are generated by held-down key.
    - Typematic Delay (Msec):** Use this item to define how many milliseconds must elapse before a held-down key begins generating repeat characters.
  - Security Option (Setup):** If you have installed password protection, this item defines if the password is required at system start up, or if it is only required when a user tries to enter the Setup Utility.
  - APIC Mode (Enable):** This item allows you to enable or disable the APIC (Advanced Programmable Interrupt Controller) mode. APIC provides symmetric multi-processing (SMP) for systems, allowing support for up to 60 processors.
  - MPS Version Control For OS (1.4):** This item displays MPS version control for OS.
  - OS Select For DRAM > 64MB (Non-OS2):** This item is only required if you have installed more than 64MB of memory and you are running the OS/2 operating system. Otherwise, leave this item at the default.
  - HDD S.M.A.R.T Capability (Disabled):** When you enable HDD SMART (Self-Monitoring, Analysis and Reporting Technology) Capability, these new BIOSes will automatically check the hard disk's SMART status at boot-up.
  - Report No FDD For WIN 95 (Disabled):** Set this item to the default if you are running a system with no floppy drive and using Windows 95. This ensures compatibility with the Window 95 logo certification.
  - Silent Boot (Enabled):** If enabled, BIOS will show a full screen logo at boot. If disabled, BIOS will set the initial display mode to BIOS and show the diagnostic POST screen at boot.
  - Small Logo (EPA) Show (Disabled):** This item enabled or disables the display of the EPA logo during boot.
  - Configuration Table (Disabled):** Use this item to show summary screen.

# Advanced Chipset Features

These items define critical timing parameters of the main board. You should leave the items on this page at their default values unless you are very familiar with the technical specifications of your system hardware. If you change the values incorrectly, you may introduce fatal errors or recurring instability into your system.

## Phoenix-AwardBIOS CMOS Setup Utility Advanced Chipset Feature

System BIOS Cacheable	[Enabled]	Item Help
Video BIOS Cacheable	[Disabled]	
Memory Hole At 15M-16M	[Disabled]	
▶ PCI Express Root Port Func	[Press Enter]	Menu Level ▶
** VGA Setting **		
PEG/Onchip VGA Control	[Auto]	
On-Chip Frame Buffer Size	[ 8MB]	
DVMT Mode	[DVMT]	
DVMT/FIXED Memory Size	[ 128MB]	

↑↓→←: Move Enter: Select +/-/PU/PD:Value F10:Save ESC:Exit F1:General Help  
F5:Previous Values F7:Optimized Defaults

- System BIOS Cacheable (Enable):** This item allows the system to be cached in memory for faster execution. Enable this item for better performance.
- Video BIOS Cacheable (Disabled):** This item aims to further boost the performance of a shadowed video BIOS by caching it using the processor's Level 2 cache.
- Memory Hole At 15M-16M (Disable):** In order to improve performance, certain space in memory can be reserved for ISA cards. This memory must be mapped into the memory space below 16MB.

- ❑ **PCI Express Root Port Func (Press Enter):** Scroll to this item and press <Enter> to view the following screen.

Phoenix-AwardBIOS CMOS Setup Utility  
PCI Express Root Port Func

<table style="width: 100%; border-collapse: collapse;"> <tr> <td style="padding: 2px;">PCI Express Port 1</td> <td style="text-align: right; padding: 2px;">[Auto]</td> </tr> <tr> <td style="padding: 2px;">PCI Express Port 2</td> <td style="text-align: right; padding: 2px;">[Auto]</td> </tr> <tr> <td style="padding: 2px;">PCI Express Port 3</td> <td style="text-align: right; padding: 2px;">[Auto]</td> </tr> <tr> <td style="padding: 2px;">PCI Express Port 4</td> <td style="text-align: right; padding: 2px;">[Auto]</td> </tr> <tr> <td style="padding: 2px;">PCI Express Port 5</td> <td style="text-align: right; padding: 2px;">[Auto]</td> </tr> <tr> <td style="padding: 2px;">PCI Express Port 6</td> <td style="text-align: right; padding: 2px;">[Auto]</td> </tr> <tr> <td style="padding: 2px;">PCI-E Compliancy Mode</td> <td style="text-align: right; padding: 2px;">[v1.0a]</td> </tr> </table>	PCI Express Port 1	[Auto]	PCI Express Port 2	[Auto]	PCI Express Port 3	[Auto]	PCI Express Port 4	[Auto]	PCI Express Port 5	[Auto]	PCI Express Port 6	[Auto]	PCI-E Compliancy Mode	[v1.0a]	<table style="width: 100%; border-collapse: collapse;"> <tr> <td style="text-align: center; padding: 5px;">Item Help</td> </tr> <tr> <td style="padding: 5px;">Menu Level   ► ►</td> </tr> </table>	Item Help	Menu Level   ► ►
PCI Express Port 1	[Auto]																
PCI Express Port 2	[Auto]																
PCI Express Port 3	[Auto]																
PCI Express Port 4	[Auto]																
PCI Express Port 5	[Auto]																
PCI Express Port 6	[Auto]																
PCI-E Compliancy Mode	[v1.0a]																
Item Help																	
Menu Level   ► ►																	

↑↓ → ← : Move   Enter: Select   +/-/PU/PD: Value   F10: Save   ESC: Exit   F1: General Help  
F5: Previous Values   F7: Optimized Defaults

- ❑ **PCI-E Compliancy Mode (1.0a):** This item allows you to select the PCI-E Compliancy mode.
- ❑ **PEG/Onchip VGA Control (Auto):** This item allows you to control the PEG or on-chip VGA.
- ❑ **On-Chip Frame Buffer Size (8MB):** This item controls the amount of system memory that is allocated to the integrated graphics processor when the system boots up.
- ❑ **DVMT Mode (DVMT):** this item allows you to select the DVMT operating mode.
- ❑ **PEG/On-chip VGA Control (128MB):** This item allows you to adjust the shared memory size.



# Integrated Peripherals

These options display items that define the operation of peripheral components on the system's input/output ports.

## Phoenix-AwardBIOS CMOS Setup Utility Integrated Peripherals

<ul style="list-style-type: none"> <li>▶ OnChip IDE Device [Press Enter]</li> <li>▶ Onboard Device [Press Enter]</li> <li>▶ SuperIO Device [Press Enter]</li> </ul>	<table border="1"> <tr> <th colspan="2">Item Help</th> </tr> <tr> <td>Menu Level</td> <td style="text-align: right;">▶▶</td> </tr> </table>	Item Help		Menu Level	▶▶
Item Help					
Menu Level	▶▶				

↑↓ → ← : Move Enter: Select +/-/PU/PD:Value F10:Save ESC:Exit F1: General Help  
F5:Previous Values F7:Optimized Defaults

- ❑ **OnChip IDE Device (Press Enter):** Scroll to this item and press <Enter> to view the following screen.

## Phoenix-AwardBIOS CMOS Setup Utility OnChip IDE Device

<ul style="list-style-type: none"> <li>IDE HDD Block Mode [Enabled]</li> <li>IDE DMA transfer access [Enabled]</li> <li>On-Chip Primary PCI IDE [Enabled]</li> <li>IDE Primary Master PIO [Auto]</li> <li>IDE Primary Slave PIO [Auto]</li> <li>IDE Primary Master UDMA [Auto]</li> <li>IDE Primary Slave UDMA [Auto]</li> <li>On-Chip Secondary PCI IDE [Enabled]</li> <li>IDE Secondary Master PIO [Auto]</li> <li>IDE Secondary Slave PIO [Auto]</li> <li>IDE Secondary Master UDMA [Auto]</li> <li>IDE Secondary Slave UDMA [Auto]</li> </ul> <p>*** On-Chip Serial ATA Setting ***</p> <ul style="list-style-type: none"> <li>SATA Mode AHCI</li> <li>X OnChip Serial ATA [Enabled]</li> </ul>	<table border="1"> <tr> <th colspan="2">Item Help</th> </tr> <tr> <td>Menu Level</td> <td style="text-align: right;">▶▶</td> </tr> <tr> <td colspan="2">           If your IDE hard drive supports block mode select Enabled for automatic detection of the optimal number of block read/writes per sector the drive can support         </td> </tr> </table>	Item Help		Menu Level	▶▶	If your IDE hard drive supports block mode select Enabled for automatic detection of the optimal number of block read/writes per sector the drive can support	
Item Help							
Menu Level	▶▶						
If your IDE hard drive supports block mode select Enabled for automatic detection of the optimal number of block read/writes per sector the drive can support							

↑↓ → ← : Move Enter: Select +/-/PU/PD:Value F10:Save ESC:Exit F1: General Help  
F5:Previous Values F7:Optimized Defaults

- ❑ **IDE HDD Block Mode (Enabled):** If your IDE hard drive supports block mode, select Enabled for automatic detection of the optimal number of block read/write per sector that the drive can support.





## Power Management Setup

This option lets you control system power management. The system has various power-saving modes including powering down the hard disk, turning off the video, suspending on RAM, and software power down that allows the system to be automatically resumed by certain events.

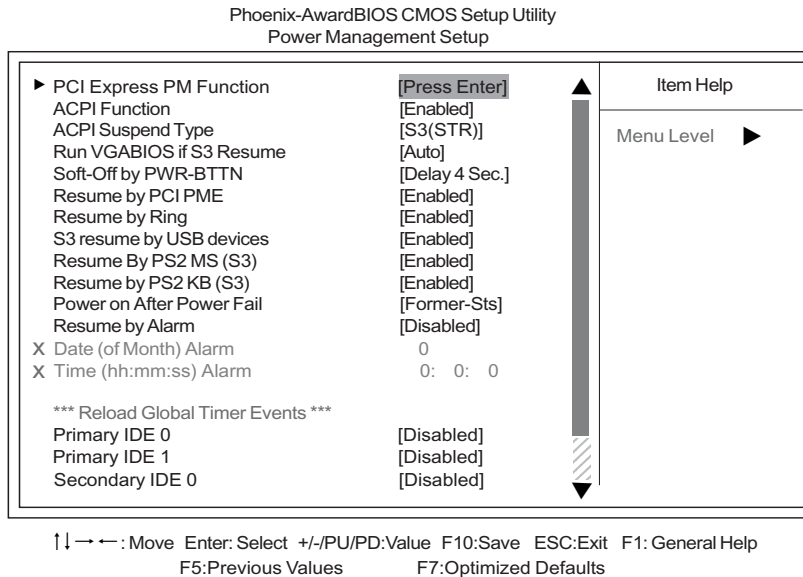

- ❑ **ACPI Function (Enabled):** Use this item to enable or disable the ACPI function.
- ❑ **ACPI Suspend Type (S3(STR)):** Use this item to define how your system suspends. In the default, S3 (STR), the suspend mode is a suspend on RAM, i.e., the system shuts down with the exception of a refresh current to the system memory.
- ❑ **Run VGA BIOS if S3 Resume (Auto):** This item allows the system to initialize the VGA BIOS from S3 (Suspend on RAM) sleep state.
- ❑ **Power Management (User Define):** Use this item to enable or disable a power management scheme. If you enable power management, you can use the items below to set the power management operation.
- ❑ **Video Off Method:** This item defines how the video is powered down to save power. This item is set for DPMS (Display Power Management Software) by default.
- ❑ **Suspend Type (Stop Grant):** If this item is set to the default Stop Grant, the CPU will go into Idle Mode during power saving power.
- ❑ **Modem Use IRQ (3):** If you want an incoming call on a modem to automatically resume the system from a power-saving mode, use this item to specify the interrupt request line (IRQ) that is used by the modem. You might have to connect the fax/modem to the main board Wake On Modem connector for the feature to work.
- ❑ **Suspend Mode (Disabled):** This item allows you to enable or disable the suspend mode.
- ❑ **HDD Power Down (Disabled):** The IDE hard drive will spin down if it is not accessed within a specified length of time.
- ❑ **Soft-Off by PWR-BTTN (Instant-Off):** Under ACPI (Advanced Configuration and Power Management Interface) you can create a software power down. In a software power down, the system can be resumed by Wake Up Alarms. This item lets you install a software power down that is controlled by the power button on your system. If the item is set for Instant-Off, then the power button causes a software power down. If the item is set for Delay four Sec., then you have to hold

---

the power button down for four seconds to cause a software power down.

- Resume by PCI PME (Enabled):** This item specifies whether the system will be awakened from power-saving modes when activity or input signal of the specified hardware peripheral or component is detected.
- Resume by Ring (Enabled):** An input signal on the serial Ring indicator (RI) line (in other words, an incoming call on the modem) awakens the system from soft off state.
- S3 resume by USB devices (Disabled):** This option allows the activity of the USB devices (keyboard and mouse) to wake up the system from S3 sleep state.
- Resume by PS2 MS/KS (S3) (Disabled):** Enable or disable the function of waking up the system by the mouse/keyboard activity.
- Power on After Power fail (Off):** This item enables your computer to automatically restart or return to its last operating status after power returns from a power failure.
- Resume by Alarm (Disabled):** When it is set to Enabled, additional fields become available and you can set the data (day of the month), hour, minute and second to turn on your system. When it is set to zero for the day of the month, the alarm will power on your system every day at the specified time.
- \*\*Reload Global Timer Events\*\*:** Global Timer (power management) events are I/O events whose occurrence can prevent the system from entering a power saving mode or can awaken the system from such a mode. In effect, the system remains alert for anything that occurs to a device that is configured as Enabled, even when the system is in a power-down mode.
- Primary/Secondary IDE 1/0 (Disabled):** When these items are enabled, the system will restart the power-saving timeout counters when any activity is detected on any of the drives or devices on the primary or secondary IDE channels.
- FDD, COM, LPT Port (Disabled):** When this item is enabled, the system will restart the power-saving timeout counters when any activity is detected on the floppy disk drive, serial ports, or the parallel port.
- PCI PIRQ[A-D]# (Disabled):** When this item is enabled, any activity from one of the listed devices wakes up the system.



## PC Health Status

On the main boards that support hardware monitoring, this item lets you monitor the parameters for critical voltages, temperatures, and fan speeds.

### Phoenix-AwardBIOS CMOS Setup Utility PC Health Status

Smart Fan Control	[Enabled]	Item Help
CPU Warning Temperature	[70°C/158°F]	Menu Level ▶
Vcore	1.20V	
+3.3V	3.37V	
+5V	4.94V	
+12V	11.45V	
5V SB	4.94V	
Current CPU Temperature	36°C	
Current System Temperature	30°C	
Current CPU fan Speed	0 RPM	
Current System fan Speed	0 RPM	

↑↓→←: Move Enter: Select +/-/PU/PD:Value F10:Save ESC:Exit F1: General Help  
F5:Previous Values F7:Optimized Defaults

- ❑ **Smart Fan Control (Enabled):** This item enables or disables the Smart fan function, when it is set at certain temperature, the PWN value will reach the certain value accordingly, and we can adjust the CPU fan speed by PWN.
- ❑ **CPU Warning Temperature (70°C/158°F):** Enable you to manually set the warning temperature of the system.
- ❑ **System Component Characteristics:** These field provide you with information about the systems.

---

## Frequency Control

This item enables you to set the clock speed and system bus for your system. The clock speed and system bus are determined by the kind of processor you have installed in your system.

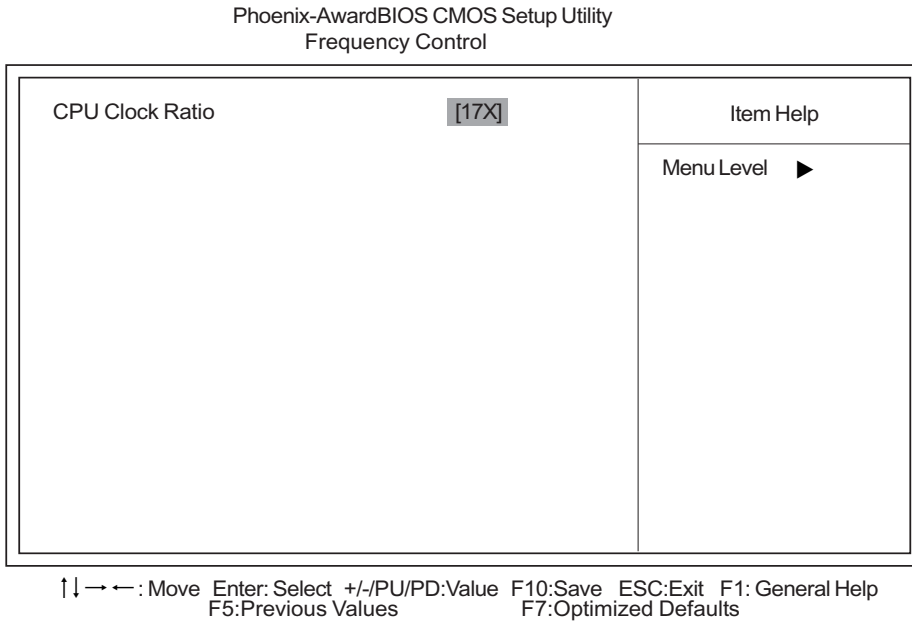

- CPU Clock Ratio (25X):** Enables you to set the CPU clock.



---

## ***Load Fail-Safe Defaults Option***

This option opens a dialog box that lets you install fail-safe defaults to all appropriate items in the Setup Utility: Press <Y> and the <Enter> to install the defaults. Press <N> and then <Enter> to not install the defaults. The Fail-Safe defaults place no great demands on the system and are generally stable. If your system does not function correctly, try to install the Fail-Safe Defaults as a first step for making your system work properly again. If you only want to install Fail-Safe Defaults for a specific option, select and display that option, and then press <F6>.

## ***Load Optimized Defaults Option***

This option opens a dialog box that lets you install optimized defaults for all appropriate items in the Setup Utility. Press <Y> and then <Enter> to install the defaults. Press <N> and then <Enter> to not install the defaults. The optimized defaults place demands on the system that may be greater than the performance level of the components, such as the CPU and the memory. You can cause fatal errors or instability if you install the optimized defaults when your hardware does not support them. If you only want to install setup defaults for a specific option, select and display that option, and then press <F7>.

**NOTE:** Please remain the factory BIOS default setting of **Load optimized Defaults** when you install Operation System onto the unit.

## ***Set Supervisor/User Password***

Type the password, up to eight characters and press <Enter>. The new password will clear any previously entered password from CMOS memory. You will be asked to confirm the password. Type the new password again and press <Enter>. You may also press <Esc> to abort the selection.

To disable password, just press <Enter> when you are prompted to enter password. A message will confirm the password being disabled. Once the password is disabled, the system will boot and you can enter BIOS Setup freely.

If you have selected **System** in **Security Option** of **BIOS Features Setup** menu, you will be prompted for the password every time the system reboots or any time you try to enter BIOS Setup.

If you have selected **Setup** in **Security Option** from **BIOS Features Setup** menu, you will be prompted for the password only when you enter BIOS Setup.

Supervisor Password has higher priority than User Password, You can use Supervisor Password when booting the system or entering BIOS Setup to modify all settings. Also you can use User Password when booting the system or entering BIOS Setup but can not modify any setting if Supervisor Password is enabled.

## ***Save & Exit Setup***

Highlight this item and press <Enter> to save the changes that you have made in the Setup Utility and exit the Setup Utility. When the Save and Exit dialog box appears, press <Y> to save and exit, or press <N> to return to the main menu.

## ***Exit without Saving***

Highlight this item and press <Enter> to discard any changes that you have made in the Setup Utility and exit the Setup Utility. When the Exit without Saving dialog box appears, press <Y> to discard changes and exit, or press <N> to return to the main menu.

**NOTE:** If you have made settings that you do not want to save, use the **Exit with Saving** item and press <Y> to discard any changes you have made.

## ***Machine Disassembly and Replacement***

---

To disassemble the computer, you need the following tools:

- Wrist grounding strap and conductive mat for preventing electrostatic discharge.
- Wire cutter.
- Phillips screwdriver (may require different size).

**NOTE:** The screws for the different components vary in size. During the disassembly process, group the screws with the corresponding components to avoid mismatches when putting back the components.

---

## ***General Information***

### ***Before You Begin***

Before proceeding with the disassembly procedure, make sure that you do the following:

1. Turn off the power to the system and all peripherals.
2. Unplug the AC adapter and all power and signal cables from the system.

---

## ***Disassembly Procedure***

This section tells you how to disassemble the system when you need to perform system service. Please also refer to the disassembly video, if available.

**CAUTION:** Before you proceed, make sure you have turned off the system and all peripherals connected to it.

## Aspire 3600 Standard Disassembly Process

### 1. Open the computer.

1-1. Place the system unit on a flat, steady surface.



1-2. Release the Lock-handle then slide the left side door out.

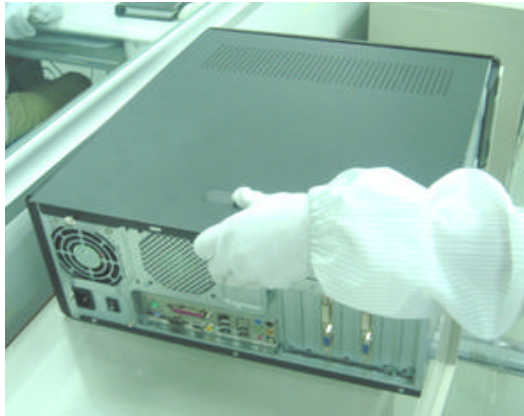

### 2. Disconnect the VGA&TV&MODEM card.

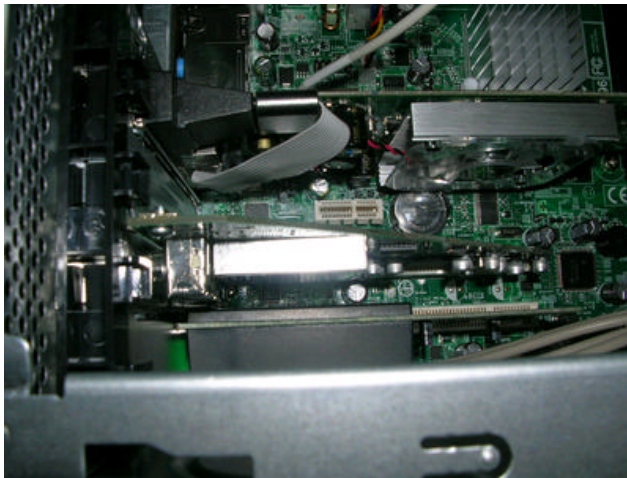

### 3. Disconnect the cables

3-1. Disconnect the front bezel LED cable.

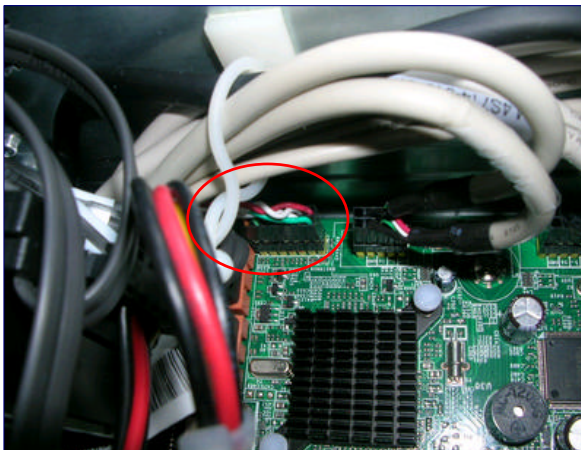

3-2.Disconnect the audio cables.

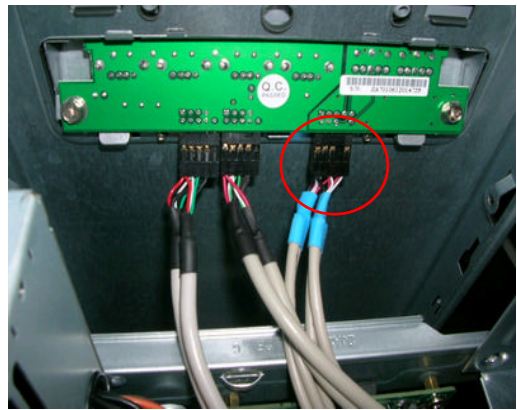
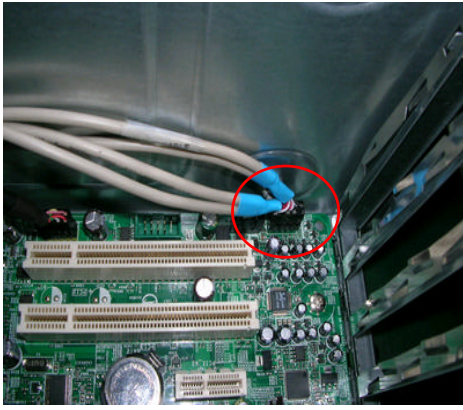

3-3.Disconnect the USB cable

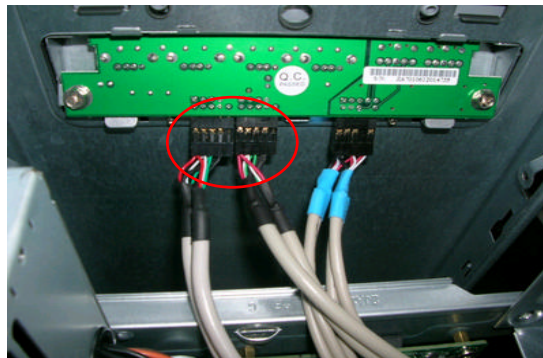
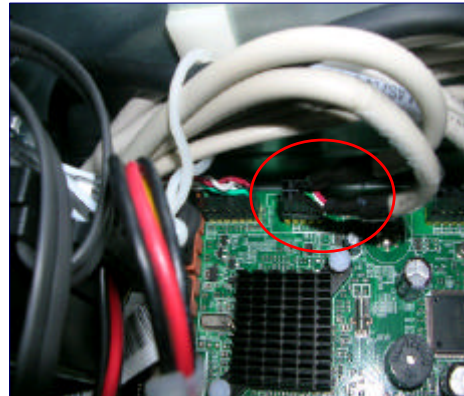
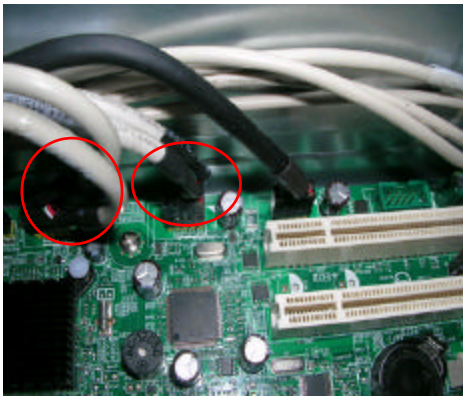

3-4.Disconnect the card read cable

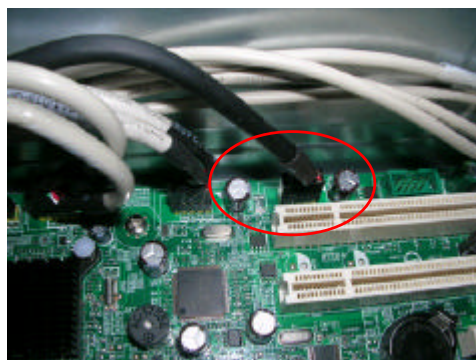



3-5. Disconnect the PA and PD power-cable to the MB connector.

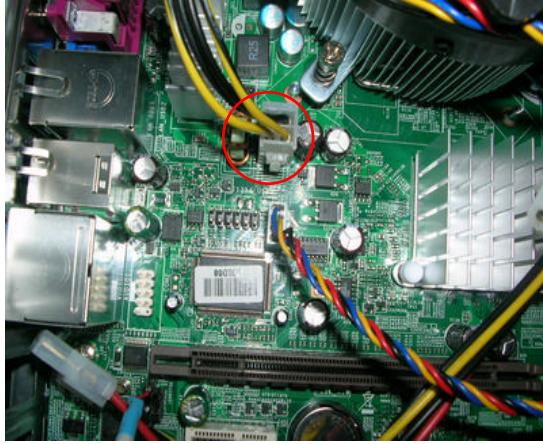

3-6. Disconnect P1 power cable and FDD data cable.

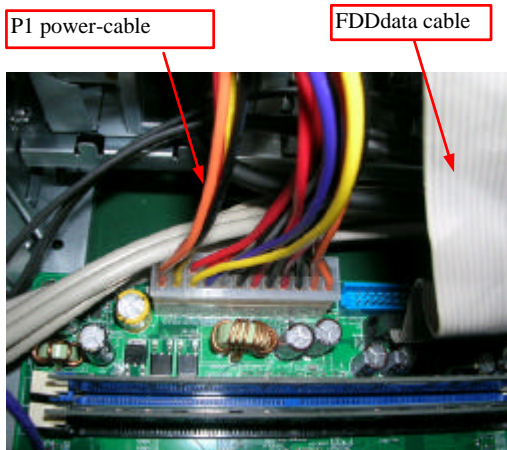

3-7. Disconnect the ODD power and data cable.

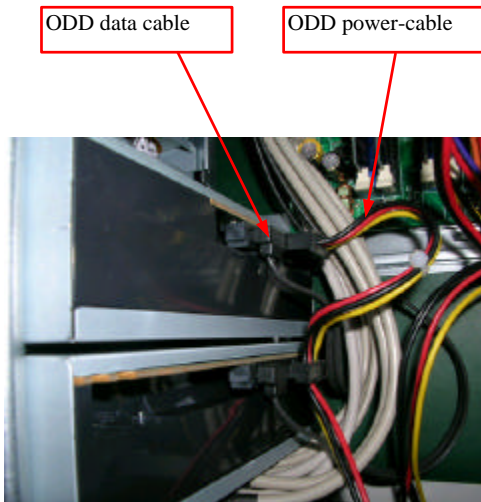

3-8. Disconnect the HDD power and data cable.

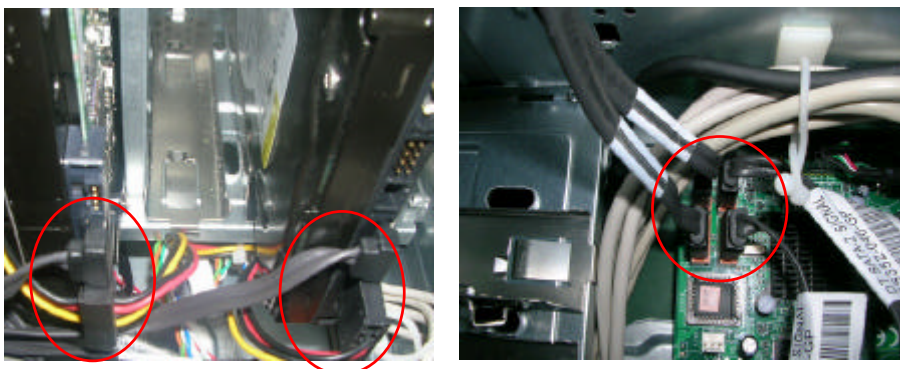

3-9. Disconnect the System Fan power-cable to the MB connector.

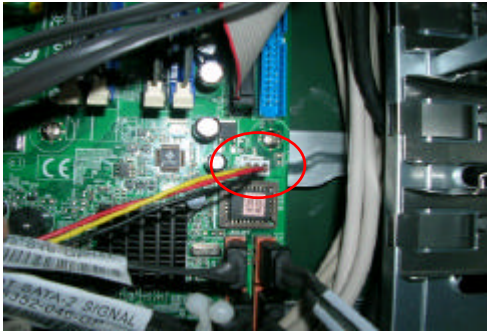

4. Disconnect the HDD

Rail the HDD-holder shown bellow, then take the HDD out from the chassis.

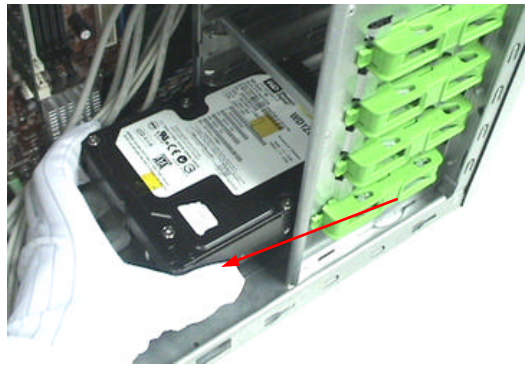
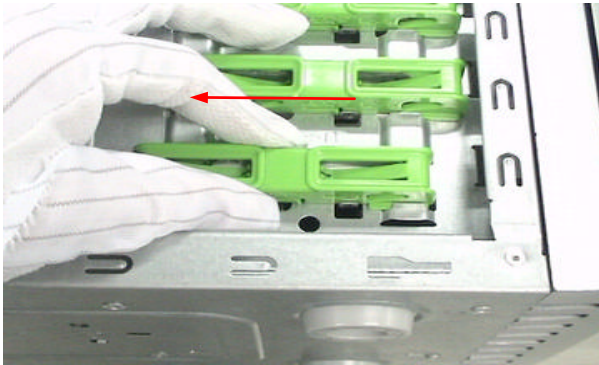

5. Release the three latches on the front bezel, then remove the front bezel.



6. Disconnect the ODD

Rail the ODD-holder shown bellow, then take the ODD out from the chassis

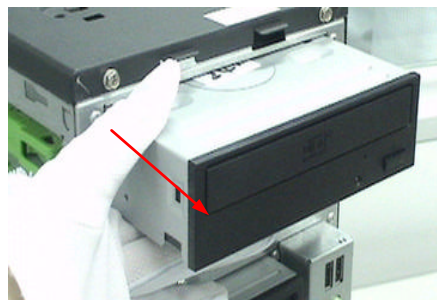
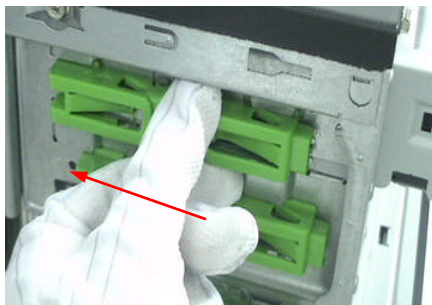



7. Install the CPU Cooler.

7-1. Release the CPU cooler from the MB.

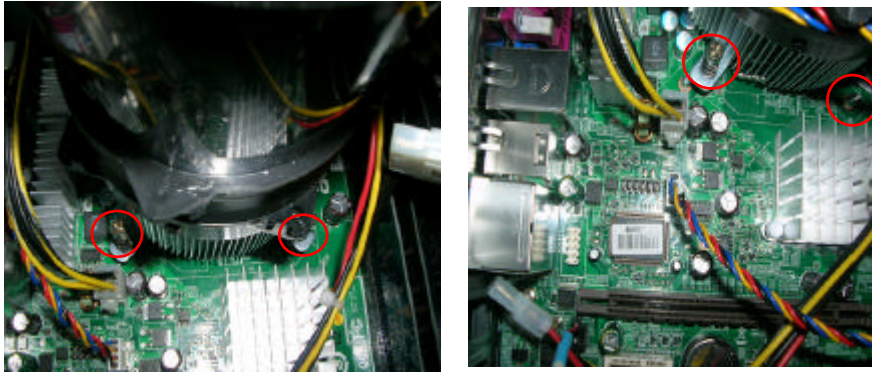

7-2. Release the CPU Cooler power-cable to the MB connector.

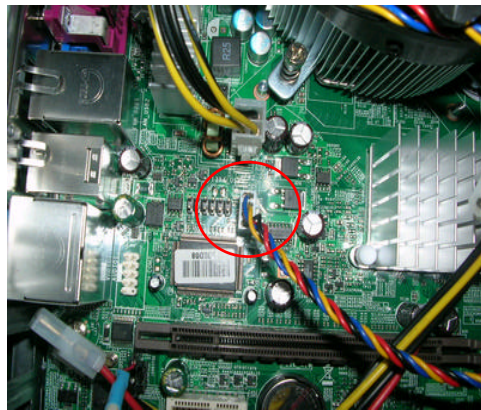

8. Release the memory.

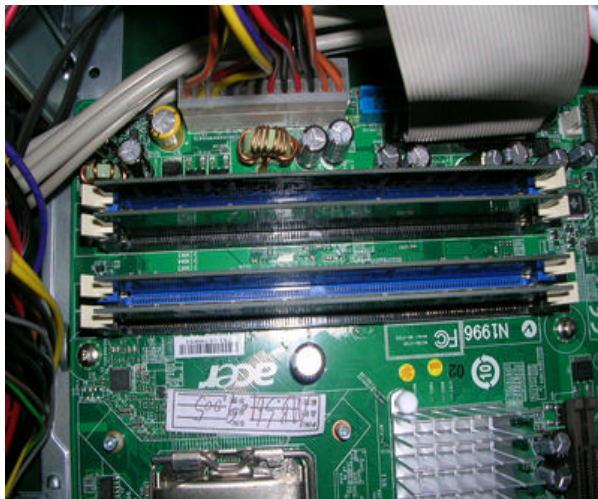

9.Remove the system FAN.

Release the four screws shown bellow then take off the fan.



10.Remove the CPU.

Release the CPU Latch on the Socket then remove the CPU.



11.Remove the motherboard

Release the eight screws shown bellow then take off the MB.

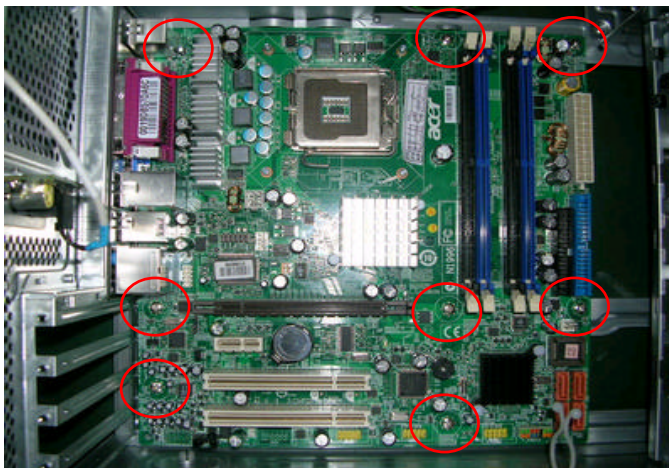

12.Remove the power-supply.

Release the four screws shown bellow then take off the Power-supply.

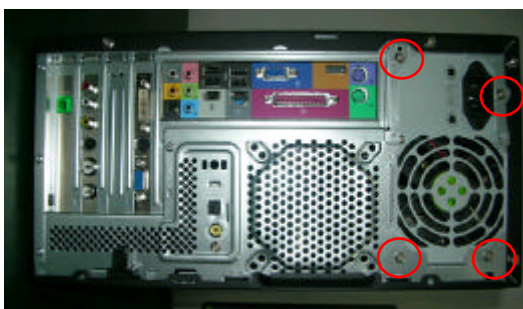



## Aspire 5600 Standard Disassembly Process

### 1. Open the computer.

1-1. Place the system unit on a flat, steady surface.



1-2. Release the Lock-handle then slide the left side door out.



### 2. Disconnect the VGA&TV&MODEM card.

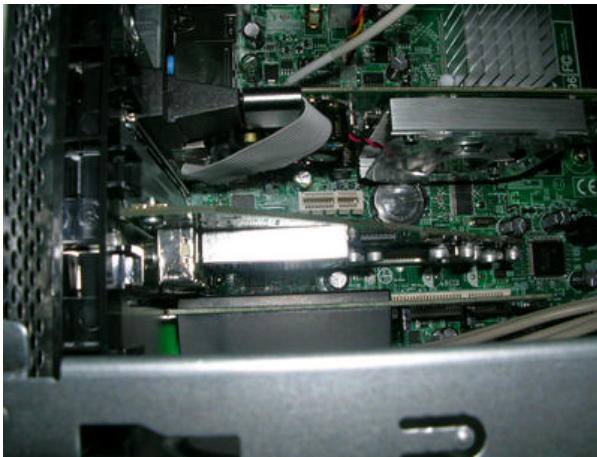

### 3. Disconnect the cables

3-1. Disconnect the front bezel LED cable.

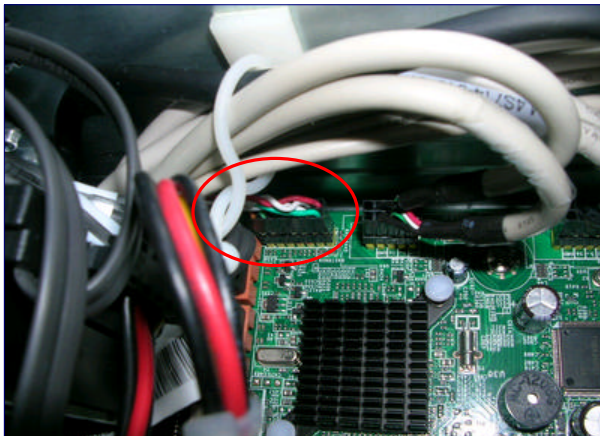

3-2.Disconnect the SPDIF cable.

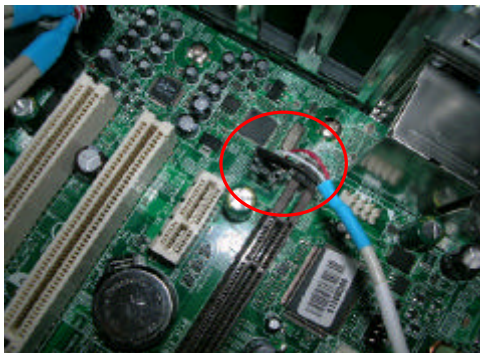
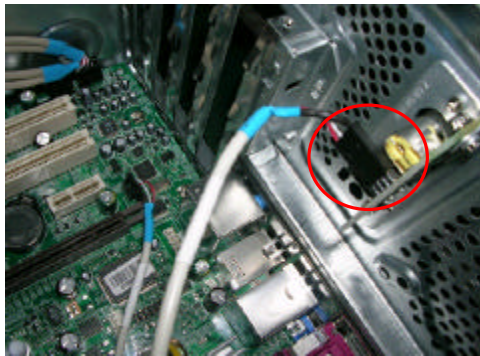

3-3.Disconnect the audio cables.



3-4.Disconnect the USB cable

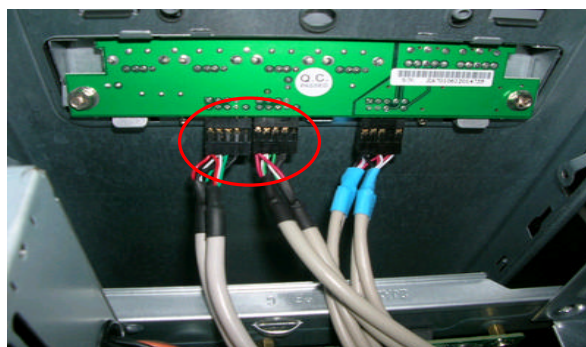
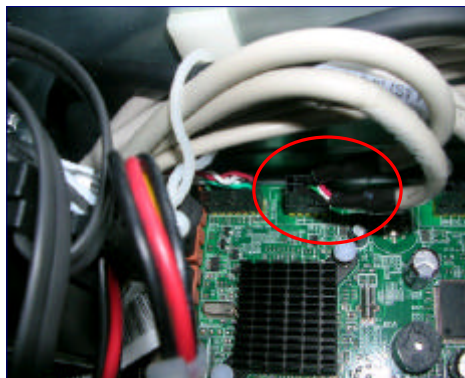
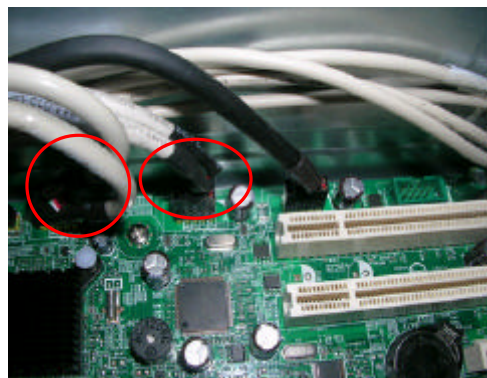

3-5.Disconnect the card read cable

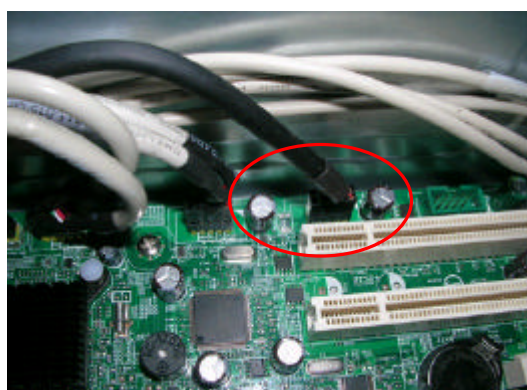



3-6.Disconnect the PA and PD power-cable to the MB connector.

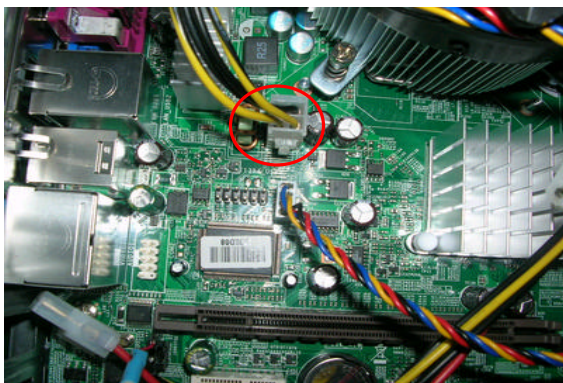

3-7.Disconnect P1 power cable and FDD data cable.

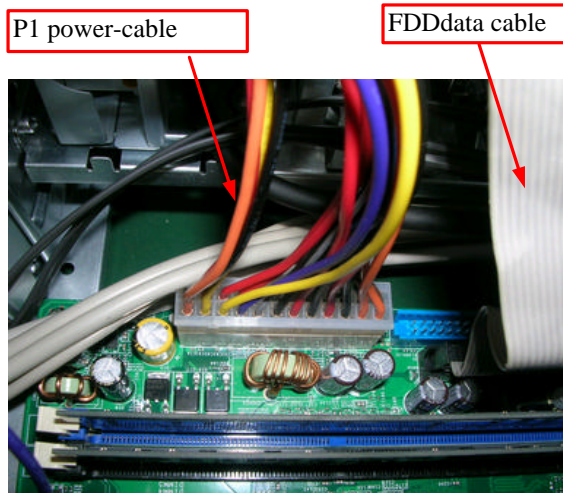

3-8.Disconnect the ODD power and data cable.

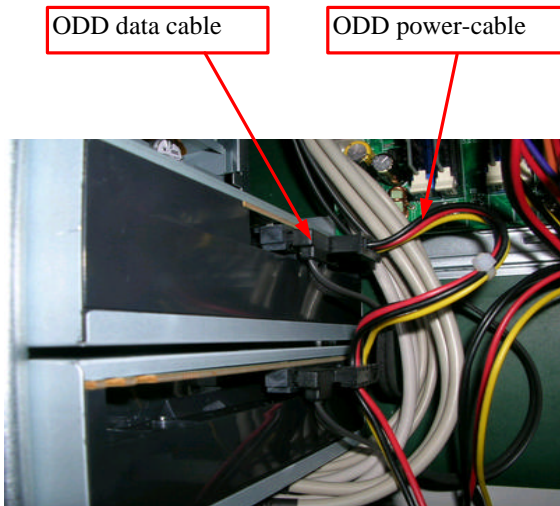

3-9.Disconnect the HDD power and data cable.

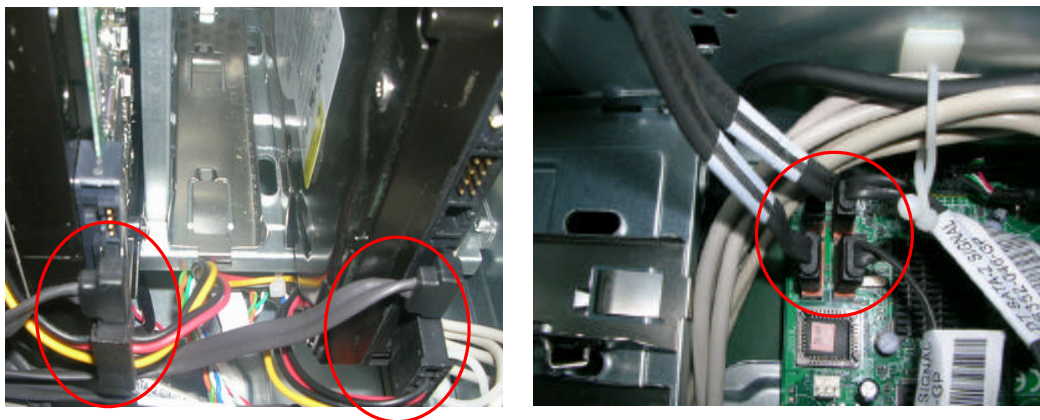

3-10. Disconnect the System Fan power-cable to the MB connector.

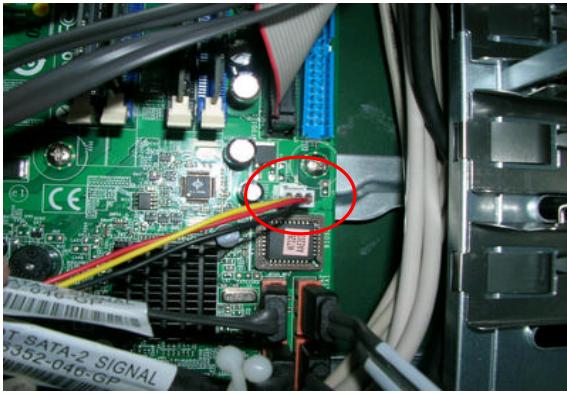

4. Disconnect the HDD

Rail the HDD-holder shown bellow, then take the HDD out from the chassis.

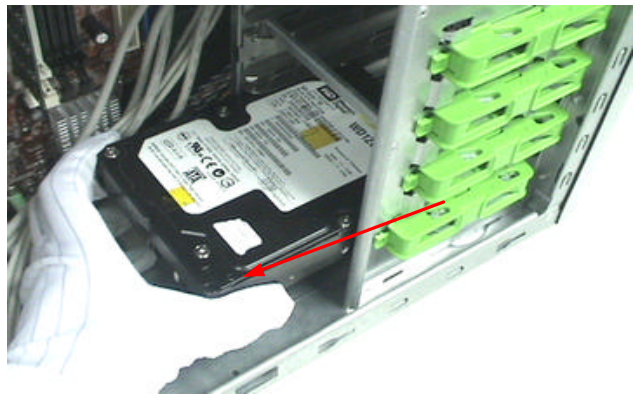
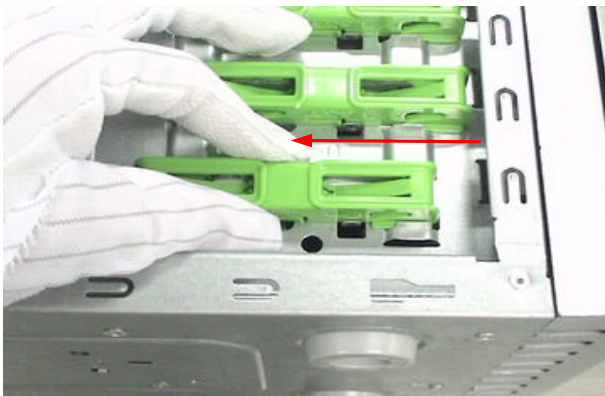

5. Release the three latches on the front bezel, then remove the front bezel.



6. Disconnect the ODD

Rail the ODD-holder shown bellow, then take the ODD out from the chassis

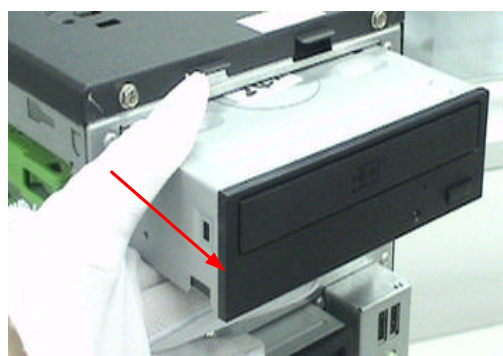
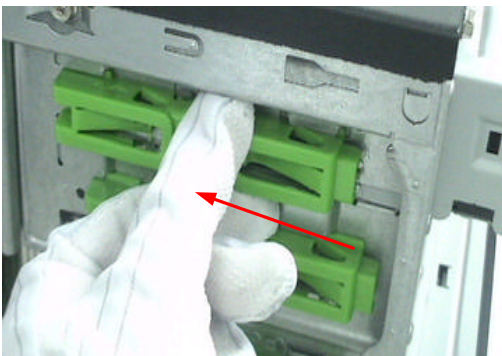



7. Install the CPU Cooler.

7-1. Release the CPU cooler from the MB.

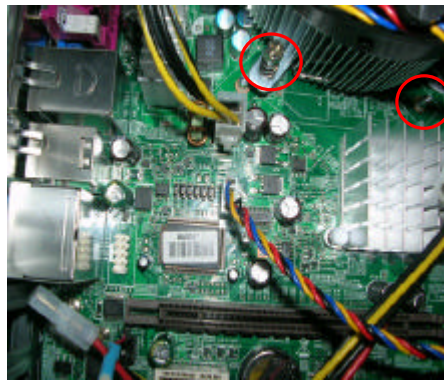
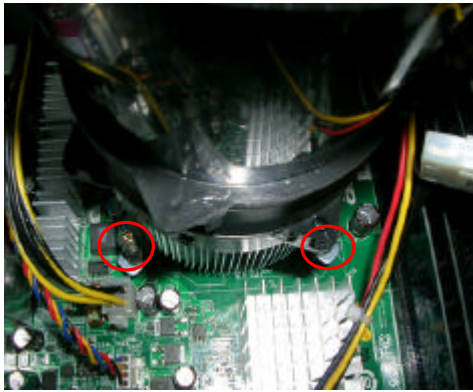

7-2. Release the CPU Cooler power-cable to the MB connector.

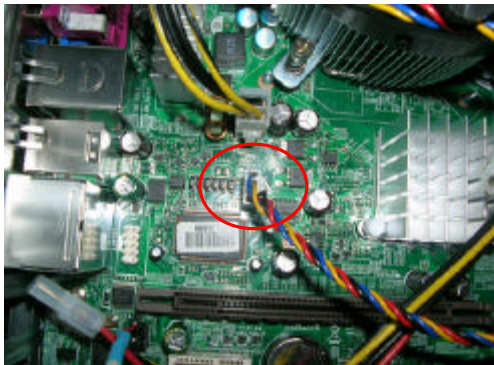

8. Release the memory.

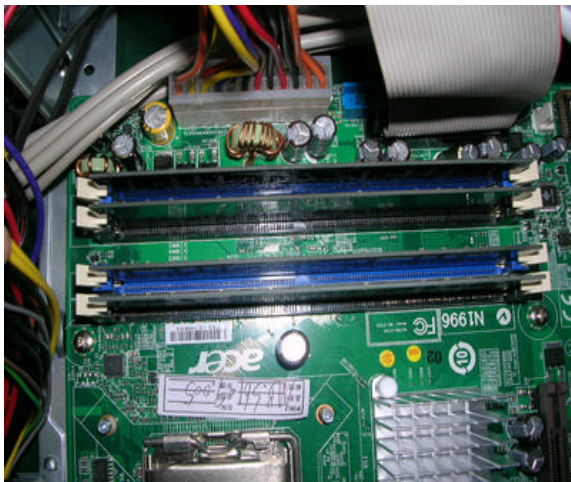

9. Remove the system FAN.

Release the four screws shown below then take off the fan.



10.Remove the CPU.

Release the CPU Latch on the Socket then remove the CPU.



Release the eight screws shown bellow then take off the MB.

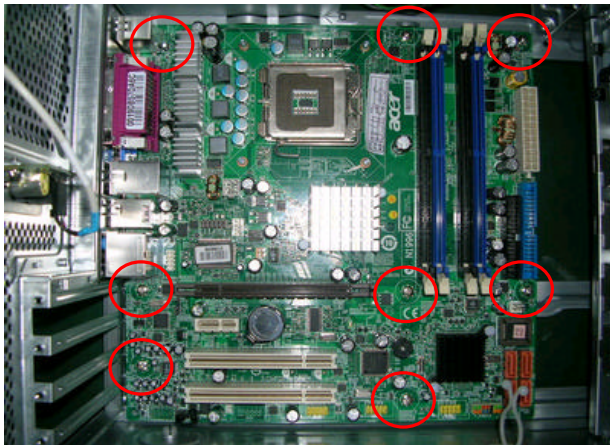

12.Remove the power-supply.

Release the four screws shown bellow then take off the Power-supply.

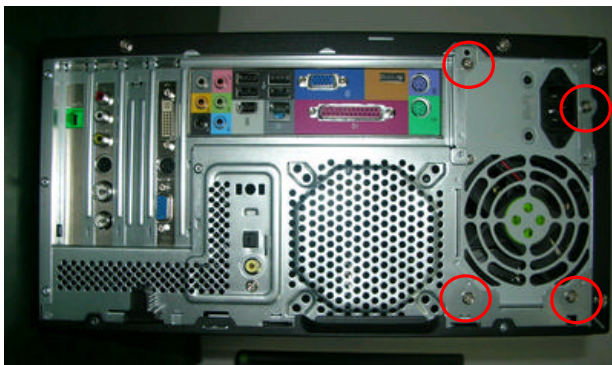



## ***Troubleshooting***

---

Please refer to generic troubleshooting guide for troubleshooting information relating to following topics:

- Power-On Self-Test (POST)
- POST Check Points
- POST Error Messages List
- Error Symptoms List



# Jumper and Connector Information

## Main Board Placement

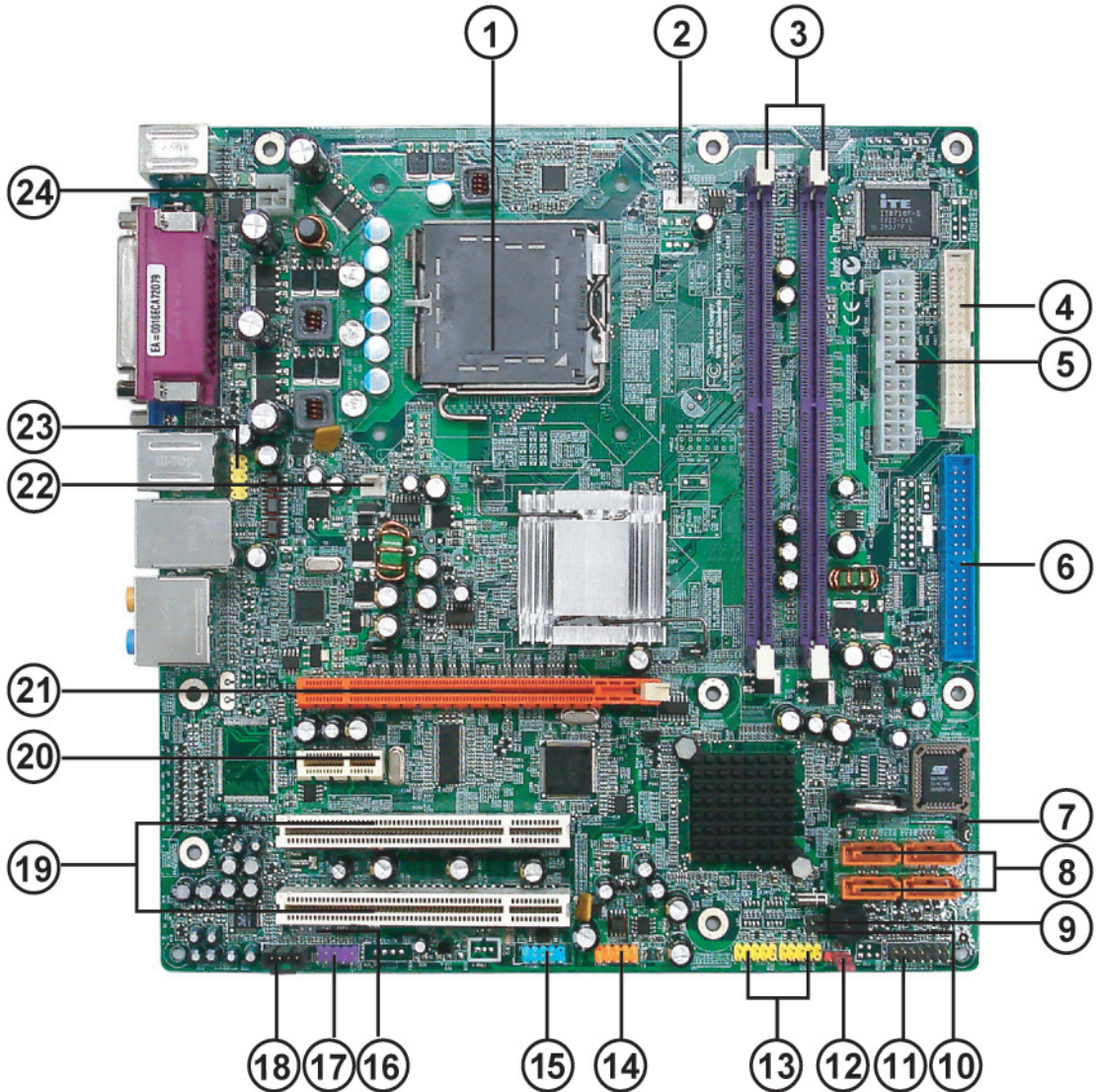

#	Label	Description	#	Label	Description
1	CPU Socket	LGA775 socket for Intel Core™ Duo / Pentium D / Pentium 4 / Celeron D CPUs	2	CPU_FAN1	CPU cooling fan connector
3	DIMM1~2	DDR2 240 pin SDRAM slots	4	FDD1	Floppy diskette drive connector

#	Label	Description	#	Label	Description
5	ATX1	Standard 24-pin ATX power connector	6	IDE1	Primary IDE channel
7	BIOS_WP	BIOS flash protect jumper	8	SATA1~4	Serial ATA connectors
9	JP2	TBD	10	JP1	TBD
11	PANEL1	Front Panel switch/LED header	12	CLR_CMOS1	Clear CMOS jumper
13	USB3~4	Front Panel USB headers	14	1394a1	Onboard 1394a header
15	COM2	Onboard Serial port header	16	SPDIF	SPDIF out header
17	AUDIO2	Front Panel Audio header	18	CD_IN1	Analog audio input connector
19	PCI1~2	32-bit add-on card slots	20	PCIEX1	PCI Express x1 slot
21	PCIEX16	PCI Express x16 slot	22	SYS_FAN1	System fan connector
23	R_USB	Front Panel USB header	24	ATA12V1	Auxiliary 4-pin power connector

---

## Jumper Setting

This section explains how to set jumpers for correct configuration of the main board.

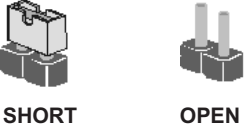
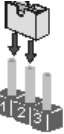

### Setting Jumper

Use the main board jumpers to set system configuration options. Jumpers with more than one pin are numbered. When setting the jumpers, ensure that the jumper caps are placed on the correct pins.

Illustration	Description
 <p data-bbox="134 556 211 580">SHORT</p> <p data-bbox="311 556 376 580">OPEN</p>	<p data-bbox="422 439 1245 528">The illustrations show a 2-pin jumper. When the jumper cap is placed on both pins, the jumper is SHORT. If you remove the jumper cap, or place the jumper cap on just one pin, the jumper is OPEN.</p>
	<p data-bbox="422 604 1093 628">This illustration shows a 3-pin jumper. Pins 1 and 2 are SHORT.</p>

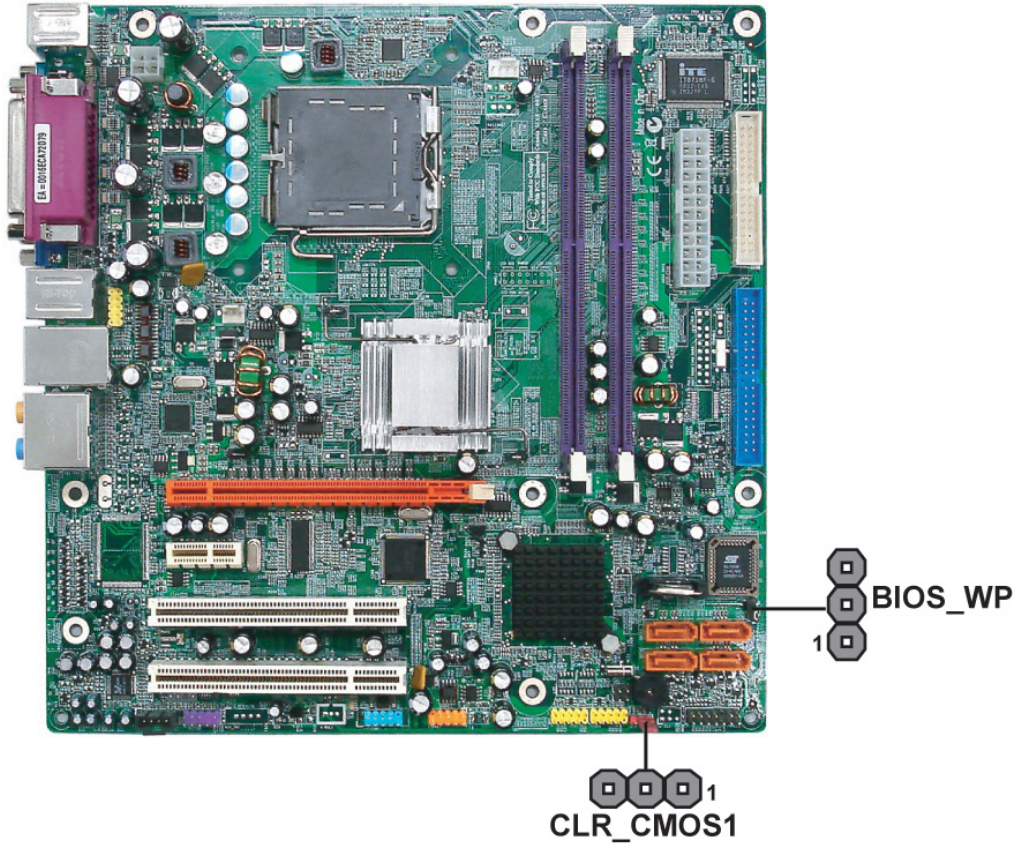
# Checking Jumper Settings



Jumper	Type	Description	Setting(Default)	Illustration
CLR_CMOS1	3-pin	CLEAR CMOS	1-2 : Normal 2-3 : Clear CMOS Before clearing the CMOS,make sure you have turned off the system.	 1
BIOS_WP	3-pin	BIOS PROTECT	1-2: Write 2-3: PROTECT	 1



## Connecting Components

1. Connect the CPU cooling fan cable to **CPU\_FAN1**.
2. Connect the system cooling fan connector to **SYS\_FAN1**.
3. Connect the case switches and indicator LEDs to the **PANEL1**.
4. Connect the standard power supply connector **ATX1**.
5. Connect the auxiliary case power supply connector to **ATX12V1**.

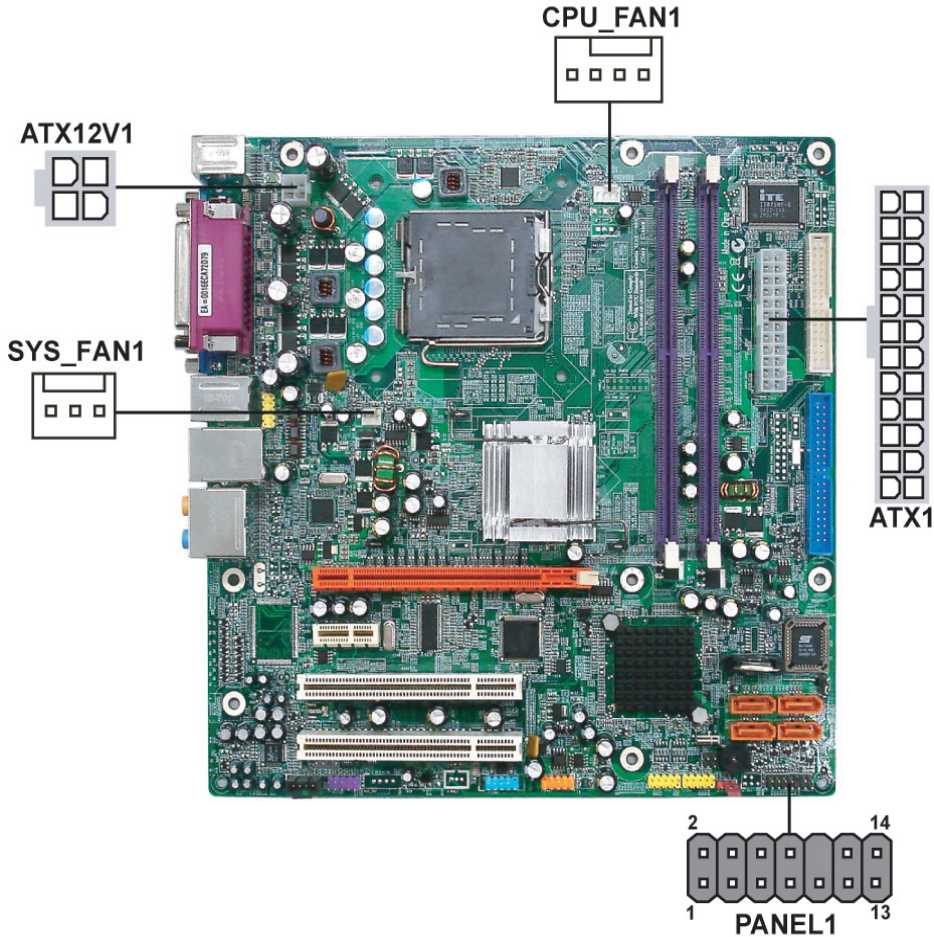

### **CPU\_FAN1: CPU Fan Connector**

Pin	Signal Name	Function
1	GND	System Ground
2	+12V	Power +12V
3	Sense	Sensor
4	Control	CPU FAN control

**NOTE:** Please note that the fan connector supports the CPU cooling fan of 1.1A ~ 2.2A (26.4W) at +12V.

### **SYS\_FAN1: System Cooling Fan Connector**

Pin	Signal Name	Function
1	GND	System Ground

### ***SYS\_FAN1: System Cooling Fan Connector***

Pin	Signal Name	Function
2	+12V	Power +12V
3	Sense	Sensor

### ***ATX1: ATX 24-pin Power Connector***

Pin	Signal Name	Pin	Signal Name
1	+3.3V	13	+3.3V
2	+3.3V	14	-12V
3	Ground	15	Ground
4	+5V	16	PS_ON
5	Ground	17	COM
6	+5V	18	COM
7	Ground	19	COM
8	PWRGD	20	-5V
9	+5VSB	21	+5V
10	+12V	22	+5V
11	+12V	23	+5V
12	+3.3V	24	Ground

### ***ATX12V1: ATX 12V Power Connector***

Pin	Signal Name
1	Ground
2	Ground
3	+12V
4	+12V

### ***Front Panel Header***

The front panel header (PANEL1) provides a standard set of switch and LED connectors commonly found on ATX or Micro ATX cases. Refer to the table below for information:

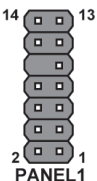
Illustration	Pin	Signal	Function	Pin	Signal	Function
 PANEL1	1	HDD_LED(+)	Hard disk LED(+)	2	Power LED (+)	Power LED (+)
	3	HDD_LED(-)	Hard disk LED(-)	4	Power LED (-)	Power LED (-)
	5	Reset_SW	Reset ground	6	PWR_SW	Power button signal
	7	Reset_SW	Reset signal	8	PWR_SW	Power button ground
	9	RSVD	Reserved	10	KEY	Key
	11	RSVD	Reserved	12	LAN_LED(+)	LAN LED(+)
	13	RSVD	Reserved	14	LAN_LED(-)	LAN LED(+)



## Connecting the Optional Devices

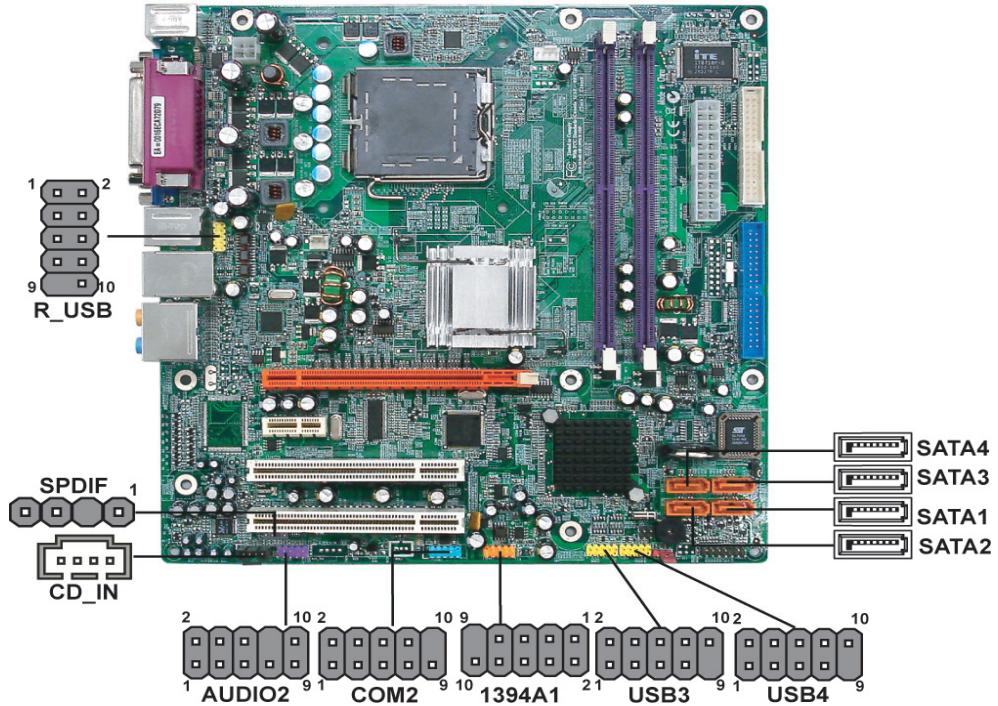

### COM2: Onboard serial port header

Pin	Signal Name	Function
1	DCDB	Data Carrier Detect
2	SINB	Serial Input
3	SOUTB	UART B Serial Output
4	DTRB	UART B Data Terminal Ready
5	GND	Ground
6	DSRB	Data Set Ready
7	RTSB	RART B Request to Send
8	CTSB	Clear to Send
9	RI	Ring Indicator
10	Key	No pin

### **AUDIO2: Front Panel Audio Header**

Pin	Signal Name
1	PORT 1L
2	GND
3	PORT 1R
4	PRESENCE#
5	PORT 2R
6	SENSE1_RETURN
7	SENSE_SEND
8	KEY
9	PORT 2L
10	SENSE2_RETURN

### **1394A1: Onboard IEEE 1394a header (optional)**

Pin	Signal Name	Pin	Signal Name
1	TPA+	6	TPB-
2	TPA1-	7	+12V
3	GND	8	+12V
4	GND	9	Key
5	TPB+	10	GND

### **SATA1~4: Serial ATA connectors**

Pin	Signal Name	Pin	Signal Name
1	Ground	5	RX-
2	TX+	6	RX+
3	TX-	7	Ground
4	Ground		

### **R\_USB/USB3~4: Front Panel USB headers**

Pin	Signal Name	Function
1	USBPWR0	Front panel USB power
2	USBPWR1	Front panel USB power
3	USB_FP_P0-	USB port 0 negative signal
4	USB_FP_P1-	USB port 1 negative signal
5	USB_FP_P0+	USB port 0 positive signal
6	USB_FP_P1+	USB port 1 positive signal
7	GND	Ground
8	GND	Ground
9	Key	No pin
10	USB_FP_OC0	Overcurrent signal

**NOTE:** Make sure that the USB cable has the same pin assignment as indicated above. A different pin assignment may cause damage or system hang-up.

**SPDIF: SPDIF out header**

Pin	Signal Name	Function
1	+5VA	5V analog Power
2	Key	No pin
3	SPDIF	SPDIF digital output
4	GND	Ground

**CD\_IN1: Auxiliary In Connector**

Pin	Signal Name	Function
1	AUX_R	AUX In right channel
2	GND	Ground
3	GND	Ground
4	AUX_L	AUX In left channel

**Rear I/O Panel Connectors**

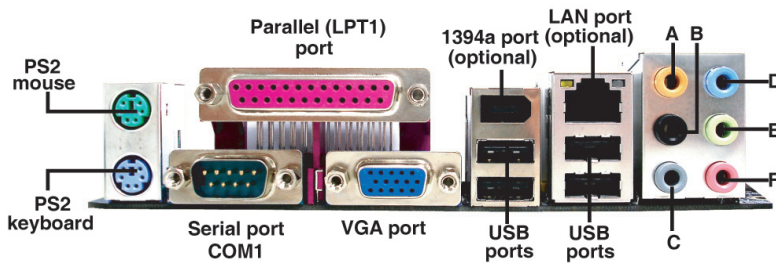

- PS2 Mouse: Use the PS/2 mouse port to connect a PS/2 pointing device.
- PS2 Keyboard: Use the PS/2 keyboard port to connect a PS/2 keyboard.
- Parallel Port (LPT1): Use LPT to connect printers or other parallel communication devices.
- Serial Port (COM1): Use the COM port to connect serial devices such as mice, fax, or modems.
- VGA Port: Connect your monitor to the VGA port.
- LAN Port (optional): Connect and RJ-45 jack to the LAN port to connect your computer to the network.
- 1394a Port (optional): Use the 1394a port to connect any firewire device.
- USB Ports: Use the USB ports to connect USB devices.
- Audio Ports: Use the audio jacks to connect audio devices The D port is for stereo line-in signal, while the F port is for microphone in signal. This main board supports 8-channel audio devices that correspond to the A, B, C, and E port respectively. In addition, all of the 3 ports, B, C, and E provide users with both right and left channels individually.



## ***FRU (Field Replaceable Unit) List***

---

This chapter gives you the FRU (Field Replaceable Unit) listing in global configurations of Aspire M5600/M3600, AcerPower M461/S461. Refer to this chapter whenever ordering for parts to repair or for RMA (Return Merchandise Authorization).

**IMPORTANT:** Please note WHEN ORDERING FRU PARTS, that you should check the most up-to-date information available on your regional web or channel. For whatever reasons a part number change is made, it will not be noted in the printed Service Guide. For ACER-AUTHORIZED SERVICE PROVIDERS, your Acer office may have a DIFFERENT part number code to those given in the FRU list of this printed Service Guide. You MUST use the local FRU list provided by your regional Acer office to order FRU parts for repair and service of customer machines.

**IMPORTANT:** Please note that Acer Corporation sells only the parts listed in the following table. Please be reminded that though some parts are disassembled in Chapter 3 for demonstration purpose, Acer Corporation does not provide these parts.

**NOTE:** To scrap or to return the defective parts, you should follow the local government ordinance or regulations on how best to dispose it, or follow the rules set by your regional Acer office on how to return it. You can access to the website for the latest Parts version <http://aicsl.acer.com.tw/spl/>

**NOTE:** The final version of SPL will be released later.

# Exploded Diagram

ITEM	DESCRIPTION	ITEM	DESCRIPTION
1	3.5" FILLER PANEL	12	USB JACK
2	3.5" BAY COVER	13	RIGHT-SIDE
3	VESA MOUNT	14	CHASSIS
4	CD-ROM	15	POWER-SUPPLY
5	FDD-VITH-PANEL	16	FAN
6	HDD-DISK	17	PCI-BKT
7	MOTHER BOARD	18	LEFT-SIDE
8	HDD-LOCK-SLIDE		
9	FDD-LOCK-SLIDE		
10	CDROM-LOCK-SLIDE		
11	USB BOARD		

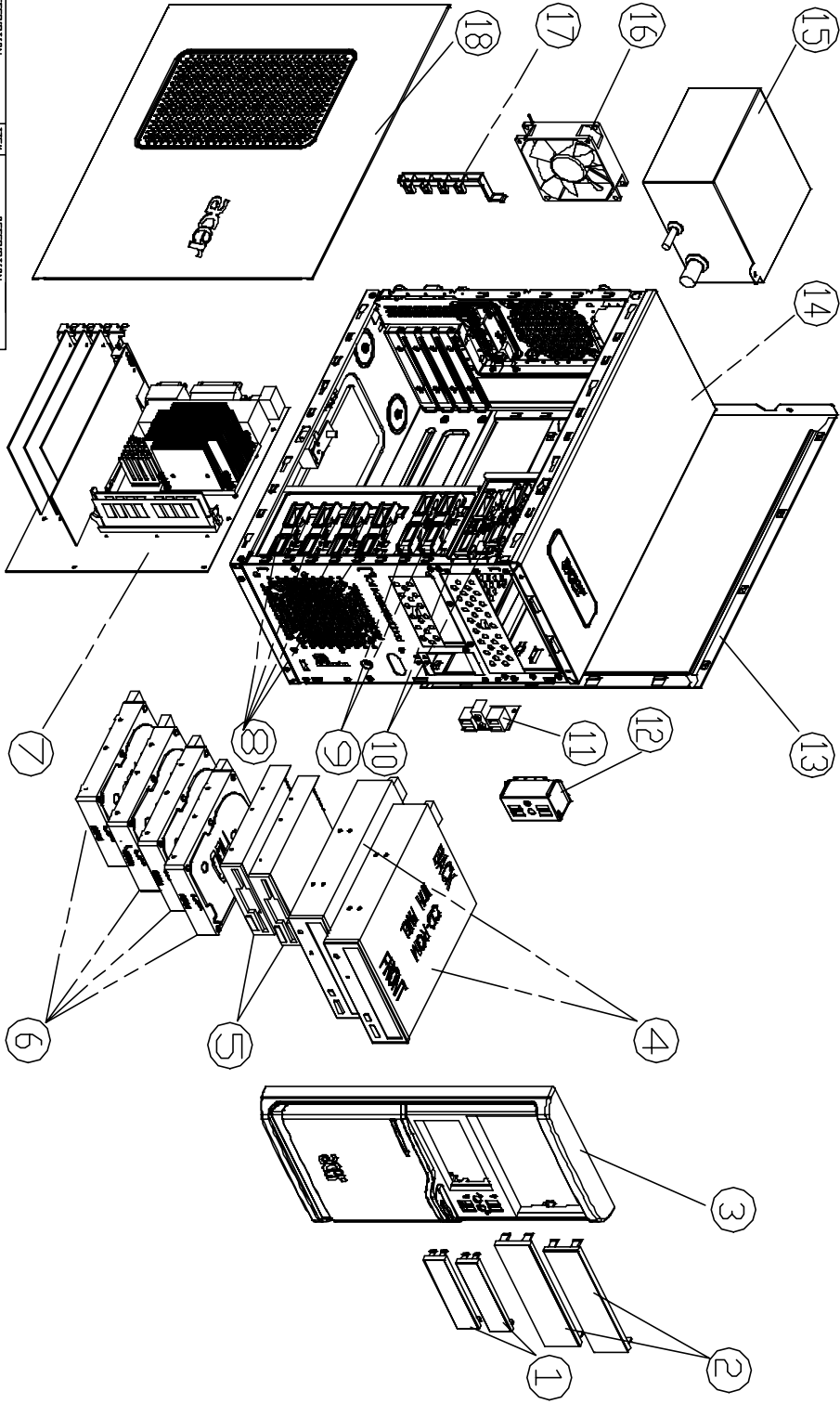

# FRU List

## Aspire M3600

CATEGORY	PARTNAME	DESCRIPTION	ACER PART NO.
BOARD	USB BOARD	USB BOARD	55.S950A.001
BOARD	POWER SWITCH DB	POWER SWITCH DB	55.P22VF.002
CARD READER	"CARD READER+1394+IR CR503U2 W/I HOUSING, W/I 1394 CABLE+USB CABLE KYE"	CR503U2	PZ.CR50J.003
CARD READER	"USB1.1, 9 IN4 W/ONE USB PORT 3.5"" LONG BAY READER GLF-680-070-126"	GLF-680-070-126	PZ.CR90K.002
CARD READER	"3.5"" USB1.1 9-IN-1 CARD READER, WITH USB CABLE , WITH IMPROVED USB CONNECTOR,SUPPORT USB2.0"	NEW CR126	CR.10400.002
CABLE	"USB CABLE, 610MM"	"USB CABLE, 610MM"	50.S950A.001
CABLE	"AUDIO CABLE, 720MM"	"AUDIO CABLE, 720MM"	50.S950A.002
CABLE	LED CABLE	LED CABLE. 520MM	50.S950A.003
CABLE	FRONT PANEL CABLE. 4PINS	FRONT PANEL CABLE. 4PINS	50.S950A.004
CABLE	IDE CD-ROM CABLE ATA66 40PIN	"CDROM DATA CABLE, ROHS"	50.S46VF.008
CABLE	HDD CABLE SATA_1	"SATA-HDD DATA CABLE, ROHS"	50.S46VF.001
CABLE	SERIAL ATA DATA CABLE FOR ODD	SERIAL ATA DATA CABLE FOR ODD	50.P40VF.003
CABLE	SARIAL ATA POWER CABLE	SARIAL ATA POWER CABLE	50.P37VF.002
CABLE	"IDE FDD CABLE 34PIN,ROHS"	"FDD DATA CABLE, ROHS"	50.S46VF.007
CASE/COVER/ BRACKET ASSEMBLY	I/O SHIELDING	I/O SHIELD ASSY	PZ.P2204.003
CASE/COVER/ BRACKET ASSEMBLY	H402A CHASSIS W/ SIDE DOORS W/O BEZEL AND TOP-COVER (PAINTED)	H402 CHASSIS W/ SIDE DOORS W/O BEZEL AND TOP- COVER (PAINTED)	60.S950A.001
CASE/COVER/ BRACKET ASSEMBLY	UPPER-CASE(PAINTED)	UPPER CASE(PAINTED)	60.S950A.002
CASE/COVER/ BRACKET ASSEMBLY	USB HOLDER ASSY	USB HOLDER ASSY	33.S950A.001
CASE/COVER/ BRACKET ASSEMBLY	RIGHT-SIDE DOOR (PAINTED)	RIGHT-SIDE COVER (PAINTED)	60.S950A.003

**Aspire M3600**

<b>CATEGORY</b>	<b>PARTNAME</b>	<b>DESCRIPTION</b>	<b>ACER PART NO.</b>
CASE/COVER/ BRACKET ASSEMBLY	LEFT-SIDE DOOR (PAINTED)	LEFT-SIDE COVER (PAINTED)	60.S950A.004
CASE/COVER/ BRACKET ASSEMBLY	SMALL COVER WITH ACER LOGO WITH USB HOLE (PLASTIC)	SMALL COVER WITH ACER LOGO WITH USB HOLE (PLASTIC)	42.S950A.001
CASE/COVER/ BRACKET ASSEMBLY	USB MYLAR	USB MYLAR	47.S950A.001
CASE/COVER/ BRACKET ASSEMBLY	AM300 BEZEL (W/I POWER BUTTON_FDODDCOVER_LE D CABLE _POWER SWITCH DB)	AM300 BEZEL (W/I POWER BUTTON_FDODDCOV ER_LED CABLE _POWER SWITCH DB)	60.S950A.005
CASE/COVER/ BRACKET ASSEMBLY	FDD COVER FOR AM100 300 500 BEZEL	FDD COVER FOR AM100 300 500 BEZEL	42.S950A.002
CASE/COVER/ BRACKET ASSEMBLY	ACER LOGO	ACER LOGO	47.P35VF.001
ADD-ON CARD	"SP RADEON X1550 512MB HM (ONBOARD 64MB) DDR2(HYNIX) 32-BITS VGA+DVI-I+TVO PAL W/ATX BKT,88-DC92-0C-AC,ROHS"	88-DC92-0C-AC	54.X1550.H31
ADD-ON CARD	"SP RADEON X1550 512MB HM (ONBOARD 64MB) DDR2(HYNIX) 32-BITS VGA+DVI-I+TVO NTSC W/ATX BKT,88-DC92-0C-AC,ROHS"	88-DC92-0C-AC	54.X1550.H32
ADD-ON CARD	"SP ATI RADEON X1650SE 512MB HM ONBOARD 256M 64BIT DDR2(HYNIX) VGA+TVO+DVI-I PAL W/ATX BKT, 88-9C92-0C-AC, ROHS"	88-9C92-0C-AC	54.X1650.S01
ADD-ON CARD	"LIFEVIEW DUAL TV TUNER CARD W/I(ATX/FM ANTTENNA/AV IN CABLE/ PAL-NTSC CONVERTOR/ DVB-T ANTENNA),REV C,ROHS"	"HYBRID TV CARD LR306N ( W.W. ANALOG TV / DVB-T )/W/I FM, INCLUDING FM ANTENNA"	TU.30605.005
ADD-ON CARD	WINTV-HVR1110 DVB-T PAL OXFORD2 67559 REV B1B4	WINTV-HVR-1110	TV.HAUOX.BT2
ADD-ON CARD	"PRONET PCI MODEM CARD HPI56M3F W/ATX BKT, ROHS"	"PRO-NETS PCI MODEM CARD W/ AUS REGULATORY LABEL,HPI56M3F,ATX, ROHS,FOR WORDWIDE"	FX.56M03.003
ADD-ON CARD	D-1156I#/A7A	D-1156I#/A7A	FX.15602.001
ADD-ON CARD	"PC PARTNER GEFORCE 7500LE TC 512MB ON-BOARD 128MB/64BIT DDR2 (HYNIX) VGA+TVO+DVI-I PAL W/ATX BKT,88-4N01-2C-AC, ROHS,"	88-4N01-2C-AC	VG.PC75L.E15



**Aspire M3600**

CATEGORY	PARTNAME	DESCRIPTION	ACER PART NO.
ADD-ON CARD	PC PARTNER GEFORCE 8300GS 128MB DDRII (64BITS) VGA+TVO+DVI PAL W/ATX BKT ROHS		VG.PC83G.S01
DVD RW DRIVE	"HLDS DVD-DUAL GSA-H21N, LF , DASP, SIP 5.0 , NEW BEZEL, FOR VISTA, F/W:1.01"	GSA-H21N	KU.0160D.024
DVD RW DRIVE	"HLDS SATA DVD-DUAL GSA-H31N LF , SATA , SIP 5.0 , NEW BEZEL , F/W: 1.01, FOR VISTA"	GSA-H31N	KU.0160D.025
DVD RW DRIVE	"LITE-ON 16X DVD-DUAL DH-16W1P PATA , F/W: LA11, ROHS"	DH-16W1P	KU.01609.001
DVD RW DRIVE	"HLDS 16X DVD-DUAL GSA-H41N, F/W: RA00,ROHS"	GSA-H41N	KU.0160D.030
DVD RW DRIVE	"16X SUPERMULTI MODEL:DH-16A1P,ROHS F/W RA11"	DH-16A1P	KU.01609.003
DVD RW DRIVE	16X SUPER MULITI GSA-H40N LF	GSA-H40N	KU.0160D.029
COMBO MODULE	"LITE-ON COMBO DH-52C1P ROHS, F/W: KA11"	DH-52C1P	KO.05209.013
CPU/PROCESSES	CPU E6420 2.13G/4M/1066FSB B2 R	CPU E6420 2.13G/4M/1066FSB B2 R	KC.64201.DE0
CPU/PROCESSES	CORE 2 DUO E6400 (2.13G 2M 1066FSB) L2	E6400	KC.64001.DEL
CPU/PROCESSOR	CORE 2 DUO E6600 (2.4G 4M 1066FSB) B2	HH80557PH0564M	KC.66001.DE0
CPU/PROCESSOR	CPU CORE 2 DUO E6300 1.86G/2M/1066 R	CPU CORE 2 DUO E6300 1.86G/2M/1066 R	KC.63001.DEL
CPU/PROCESSOR	CONROE E6400	C2DE6400	KC.64001.DE0
CPU/PROCESSOR	CORE 2 DUO E6300 (1.86G 2M 1066FSB)	HH80557PH0362M	KC.63001.DE0
CPU/PROCESSOR	CORE 2 DUO E4400(2.0G 2M 800FSB)L2	C2DE4400	KC.44001.DE0
CPU/PROCESSOR	CORE 2 DUO E4300(1.8G 2M 800FSB)L2	C2DE4300	KC.43001.DE0
CPU/PROCESSOR	CPU PENTIUM DUAL CORE E2160 1.8G/1M/800	CPU PENTIUM DUAL CORE E2160 1.8G/1M/800	KC.21601.DEP
CPU/PROCESSOR	P4 641 (3.2G 2M 800FSB)D0	641	KC.DD001.641
CPU/PROCESSOR	CELERON D 356 (3.33G 512K 533FSB LGA775) D-0	HH80552RE093512	KC.DD001.356

**Aspire M3600**

<b>CATEGORY</b>	<b>PARTNAME</b>	<b>DESCRIPTION</b>	<b>ACER PART NO.</b>
CPU/PROCESSOR	CELERON D 352 (3.2G 512K 533FSB LGA775) D-0	HH80552RE088512	KC.DD001.352
CPU/PROCESSOR	CPU INTEL CORE2DUAL E4500 LGA 2.2G 2M 800 775 65W M-0	C2DE4500	KC.45001.DE0
CPU/PROCESSOR	CORE 2 DUO E6320(1.86G 4M 1066FSB)B2	C2DE6320	KC.63201.DE0
CPU/PROCESSOR	CPU INTEL PENTIUMD E2140 LGA 1.6G 1M 800 775	E2140	KC.21401.DEP
FAN SINK	CPU COOLER THERMALFLY V2.0 ROHS	P300L	HI.P300L.001
FAN SINK	PKP367G01U12(WITH SUNON 9225 4200RPM FAN)	PKP367G01U12	HI.3670C.001
FDD/FLOPPY DISK DRIVE	FDD 1.44MB PANASONIC JU-256A048P BLACK	"FDD,PANASONIC,JU-256A048P BLACK"	KF.25602.003
HDD/HARD DISK DRIVE	"SEAGATE SATA2 TONKA2 160G 7200RPM 8M W/NCQ ST3160812AS, ROHS SSC OFF"	ST3160812AS	KH.16001.028
HDD/HARD DISK DRIVE	"SEAGATE GALAXY 250G SATAII 7200RPM 8MB,W/NCQ ST3250820AS ROHS SSC OFF"	ST3250820AS	KH.25001.008
HDD/HARD DISK DRIVE	"SEAGATE GALAXY 320G SATAII 7200RPM 8MB,W/NCQ ST3320820AS ROHS SSC OFF"	ST3320820AS	KH.32001.007
HDD/HARD DISK DRIVE	"HITACHI PATHFINDER2 160G 7200RPM HDS721616PLA380, W/NCQ, ROHS"	HDS721616PLA380	KH.16007.012
HDD/HARD DISK DRIVE	"WD 80G XL80SIII SATA2 7200RPM 8M WD800JD-22MSA1 W/NCQ, ROHS"	"VANCOUVER V, HDT725025VLA380"	KH.25007.009
HDD/HARD DISK DRIVE	"320GB HDT725032VLA380 SATAII 8M,ROHS"	HDT725032VLA380	KH.32007.001
HDD/HARD DISK DRIVE	"WD 250G SATA2 WD2500AAJS-22RYA0 3G 8MB LF W/NCQ,ROHS"	WD2500AAJS-22RYA0	KH.25008.017
HDD/HARD DISK DRIVE	"320G SATA2 WD3200AAJS-22RYA0 3G 8MB LF W/ NCQ,ROHS"	XL160M WD3200AAJS-22RYA0	KH.32008.011
POINTING DEVICE	PS2 OPTICAL MOUSE LF VERSION LOGITECH M-SBF96	LOGITECH M-SBF96 PS2 OPTICAL MOUSE LF VERSION	MS.PS201.002

**Aspire M3600**

<b>CATEGORY</b>	<b>PARTNAME</b>	<b>DESCRIPTION</b>	<b>ACER PART NO.</b>
POINTING DEVICE	WIRELESS RECEIVER LOGITECH	"USB RF RECEIVER, GUPPY, W/I CASE, ROHS"	RV.GPY01.006
POINTING DEVICE	"WIRELESS MOUSE, M- RAU95, ROHS LOGITECH"	"LOGITECH WIRELESS MOUSE, M-RAU95, ROHS"	MS.RAF01.004
POINTING DEVICE	"LOGITECH USB OPTICAL MOUSE, MUV ACR1, (ROHS), W/ STK LABEL"	"M-UV ACR1 (BLACK), (ROHS)"	MS.MUV01.005
POINTING DEVICE	"LOGITECH M-SBJ96 PS2 BALL MOUSE ,ROHS"	SBJ96 (BLACK)	MS.SBJ01.003
KEYBOARD	"PS/2 KEYBOARD SK1688 T.CHINESE VER. 104KEYS(WITH EKEY VISTA), NON-ROHS"	SK1688	KB.6880B.042
KEYBOARD	PS/2 KEYBOARD SK1688 THAI VER. 104KEYS(WITH EKEY VISTA) ROHS	SK1688	KB.6880B.043
KEYBOARD	PS/2 KEYBOARD SK1688 T.CHINESE VER. 104KEYS(WITH EKEY VISTA) ROHS	SK1688	KB.6880B.044
KEYBOARD	PS/2 KEYBOARD SK1688 EN VER. 104KEYS(WITH EKEY VISTA) ROHS	SK1688	KB.6880B.045
KEYBOARD	PS/2 KEYBOARD SK1688 CAFR VER. 105KEYS(WITH EKEY VISTA) ROHS	SK1688	KB.6880B.046
KEYBOARD	PS/2 KEYBOARD SK1688 SPANISH VER. 105KEYS(WITH EKEY VISTA) ROHS	SK1688	KB.6880B.047
KEYBOARD	PS2 KEYBOARD SK1688 IN'L US VER. 104KS(WITH EKEY VISTA) ROHS	SK1688	KB.6880B.048
KEYBOARD	PS/2 KEYBOARD SK1688 SPANISH LATIN VER. 105KEYS(WITH EKEY VISTA) ROHS	SK1688	KB.6880B.049
KEYBOARD	PS/2 KEYBOARD SK1688 GERMANY VER. 105KEYS(WITH EKEY VISTA) WHITE ROHS	SK1688	KB.6880B.050
KEYBOARD	PS/2 KEYBOARD SK1688 ARABIC + US VER. 104KS(WITH EKEY VISTA) ROHS	SK1688	KB.6880B.051
KEYBOARD	PS/2 KEYBOARD SK1688 PORTUGESE VER. 105KS(WITH EKEY VISTA) ROHS	SK1688	KB.6880B.052

**Aspire M3600**

<b>CATEGORY</b>	<b>PARTNAME</b>	<b>DESCRIPTION</b>	<b>ACER PART NO.</b>
KEYBOARD	PS/2 KEYBOARD SK1688 BRAZILIAN VER. 107KS(WITH EKEY VISTA) ROHS	SK1688	KB.6880B.053
KEYBOARD	PS/2 KEYBOARD SK1688 JPNESE 109KS(WITH EKEY VISTA) ROHS	SK1688	KB.6880B.054
KEYBOARD	PS/2 KEYBOARD SK1688 GERMANY VER. 105KS (WITH EKEY VISTA) ROHS	SK1688	KB.6880B.055
KEYBOARD	PS/2 KEYBOARD SK1688 ITALIAN VER. 105KS (WITH EKEY VISTA) ROHS	SK1688	KB.6880B.056
KEYBOARD	PS/2 KEYBOARD SK1688 FRENCH VER. 105KS (WITH EKEY VISTA) ROHS	SK1688	KB.6880B.057
KEYBOARD	PS/2 KEYBOARD SK1688 SWEDEN VER. 105KS (WITH EKEY VISTA) ROHS	SK1688	KB.6880B.058
KEYBOARD	PS/2 KEYBOARD SK1688 UK VER. 105KS (WITH EKEY VISTA) ROHS	SK1688	KB.6880B.059
KEYBOARD	PS/2 KEYBOARD SK1688 DUTCH VER. 105KS (WITH EKEY VISTA) ROHS	SK1688	KB.6880B.060
KEYBOARD	PS/2 KEYBOARD SK1688 SWISS VER. 105KS (WITH EKEY VISTA) ROHS	SK1688	KB.6880B.061
KEYBOARD	PS/2 KEYBOARD SK1688 BELGIUM VER. 105KS (WITH EKEY VISTA) ROHS	SK1688	KB.6880B.062
KEYBOARD	PS/2 KEYBOARD SK1688 ICELAND VER. 105KS (WITH EKEY VISTA) ROHS	SK1688	KB.6880B.063
KEYBOARD	PS/2 KEYBOARD SK1688 NORWEGIAN VER. 105KS (WITH EKEY VISTA) ROHS	SK1688	KB.6880B.064
KEYBOARD	PS/2 KEYBOARD SK1688 HEBREW VER. 104KS (WITH EKEY VISTA) ROHS	SK1688	KB.6880B.065
KEYBOARD	PS/2 KEYBOARD SK1688 POLISH VER. 105KS (WITH EKEY VISTA) ROHS	SK1688	KB.6880B.066
KEYBOARD	PS/2 KEYBOARD SK1688 SLOVENIAN VER. 105KS (WITH EKEY VISTA) ROHS	SK1688	KB.6880B.067
KEYBOARD	PS/2 KEYBOARD SK1688 SLOVAKIAN VER. 105KS (WITH EKEY VISTA) ROHS	SK1688	KB.6880B.068

**Aspire M3600**

<b>CATEGORY</b>	<b>PARTNAME</b>	<b>DESCRIPTION</b>	<b>ACER PART NO.</b>
KEYBOARD	PS/2 KEYBOARD SK1688 TURKISH Q-TYPE VER. 105KS (WITH EKEY VISTA) ROHS	SK1688	KB.6880B.069
KEYBOARD	PS/2 KEYBOARD SK1688 RUSSIAMVER. 104KS (WITH EKEY VISTA) ROHS	SK1688	KB.6880B.070
KEYBOARD	PS/2 KEYBOARD SK1688 HUNGARIA VER. 105KS (WITH EKEY VISTA) ROHS	SK1688	KB.6880B.071
KEYBOARD	PS/2 KEYBOARD SK1688 GREEK VER. 104KS (WITH EKEY VISTA) ROHS	SK1688	KB.6880B.072
KEYBOARD	PS/2 KEYBOARD SK1688 DENMARK VER. 104KS (WITH EKEY VISTA) ROHS	SK1688	KB.6880B.073
KEYBOARD	PS/2 KEYBOARD SK1688 CZECH VER. 104KS (WITH EKEY VISTA) ROHS	SK1688	KB.6880B.074
KEYBOARD	PS/2 KEYBOARD SK1688 ROMANIAN VER. 105KS (WITH EKEY VISTA) ROHS	SK1688	KB.6880B.075
KEYBOARD	PS/2 KEYBOARD SK1688 TURKEY F-TYPE VER. 105KS (WITH EKEY VISTA) ROHS	SK1688	KB.6880B.076
KEYBOARD	PS/2 KEYBOARD SK1688 FRENCH+ARABIC 105KS (WITH EKEY VISTA) ROHS	SK1688	KB.6880B.077
KEYBOARD	PS/2 KEYBOARD SK1688 ITALIAN VER S1. 105KS (WITH EKEY) ROHS	SK1688	KB.PS20B.002
KEYBOARD	PS/2 KEYBOARD SK1688 ITALIAN VER S1. 105KS (WITH EKEY VISTA) ROHS	SK1688	KB.PS20B.001
KEYBOARD	USB KEYBOARD KU-0355 US VER. 104KS(WITH EKEY VISTA) ROHS	KU-0355	KB.KUS03.222
KEYBOARD	USB KEYBOARD KU-0355 T.CHINESE VER. 104KS(WITH EKEY VISTA) ROHS	KU-0355	KB.KUS03.223
KEYBOARD	USB KEYBOARD KU-0355 S.CHINESE 104KS(WITH EKEY VISTA) ROHS	KU-0355	KB.KUS03.224
KEYBOARD	USB KEYBOARD KU-0355 IN'L US VER. 104KS(WITH EKEY VISTA) ROHS	KU-0355	KB.KUS03.225
KEYBOARD	USB KEYBOARD KU-0355 ARABIC VER. 104KS(WITH EKEY VISTA) ROHS	KU-0355	KB.KUS03.226

**Aspire M3600**

<b>CATEGORY</b>	<b>PARTNAME</b>	<b>DESCRIPTION</b>	<b>ACER PART NO.</b>
KEYBOARD	USB KEYBOARD KU-0355 THAI VER. 104KS(WITH EKEY VISTA) ROHS	KU-0355	KB.KUS03.227
KEYBOARD	USB KEYBOARD KU-0355 SPANISH VER. 105KS(WITH EKEY VISTA) ROHS	KU-0355	KB.KUS03.228
KEYBOARD	USB KEYBOARD KU-0355 CANADIAN/FRENCH VER. 105KS(WITH EKEY VISTA) ROHS	KU-0355	KB.KUS03.230
KEYBOARD	USB KEYBOARD KU-0355 BRAZILIAN VER. 107KS(WITH EKEY VISTA) ROHS	KU-0355	KB.KUS03.231
KEYBOARD	USB KEYBOARD KU-0355 JPNESE 109KS(WITH EKEY VISTA) ROHS	KU-0355	KB.KUS03.232
KEYBOARD	USB KEYBOARD KU-0355 FRENCH VER. 105KEYS (WITH EKEY VISTA) ROHS	KU-0355	KB.KUS03.262
KEYBOARD	USB KEYBOARD KU-0355 SPANISH LATIN VER. 105KS(WITH EKEY VISTA) ROHS	KU-0355	KB.KUS03.264
KEYBOARD	USB KEYBOARD KU-0355 US VER. 104KS JPN ABS(WITH EKEY VISTA) ROHS	KU-0355	KB.KUS03.233
KEYBOARD	USB KEYBOARD KU-0355 IN'L US VER. 104KS JPN ABS(WITH EKEY VISTA) ROHS	KU-0355	KB.KUS03.234
KEYBOARD	USB KEYBOARD KU-0355 ARABIC VER. 104KS JPN ABS(WITH EKEY VISTA) ROHS	KU-0355	KB.KUS03.235
KEYBOARD	USB KEYBOARD KU-0355 GERMANY VER. 105KS JPN ABS(WITH EKEY VISTA) ROHS	KU-0355	KB.KUS03.236
KEYBOARD	USB KEYBOARD KU-0355 ITALIAN VER. 105KS JPN ABS(WITH EKEY VISTA) ROHS	KU-0355	KB.KUS03.237
KEYBOARD	USB KEYBOARD KU-0355 FRENCH VER. 105KS JPN ABS(WITH EKEY VISTA) ROHS	KU-0355	KB.KUS03.238
KEYBOARD	USB KEYBOARD KU-0355 SWEDEN VER. 105KS JPN ABS(WITH EKEY VISTA) ROHS	KU-0355	KB.KUS03.239

**Aspire M3600**

<b>CATEGORY</b>	<b>PARTNAME</b>	<b>DESCRIPTION</b>	<b>ACER PART NO.</b>
KEYBOARD	USB KEYBOARD KU-0355 UK VER. 105KS JPN ABS(WITH EKEY VISTA) ROHS	KU-0355	KB.KUS03.240
KEYBOARD	USB KEYBOARD KU-0355 SPANISH VER. 105KS JPN ABS(WITH EKEY VISTA) ROHS	KU-0355	KB.KUS03.241
KEYBOARD	USB KEYBOARD KU-0355 DUTCH VER. 105KS JPN ABS(WITH EKEY VISTA) ROHS	KU-0355	KB.KUS03.242
KEYBOARD	USB KEYBOARD KU-0355 PORTUGESE VER. 105KS JPN ABS(WITH EKEY VISTA) ROHS	KU-0355	KB.KUS03.243
KEYBOARD	USB KEYBOARD KU-0355 SWISS VER. 105KS JPN ABS(WITH EKEY VISTA) ROHS	KU-0355	KB.KUS03.244
KEYBOARD	USB KEYBOARD KU-0355 BELGIUM VER. 105KS JPN ABS(WITH EKEY VISTA) ROHS	KU-0355	KB.KUS03.245
KEYBOARD	USB KEYBOARD KU-0355 ICELAND VER. 105KS JPN ABS(WITH EKEY VISTA) ROHS	KU-0355	KB.KUS03.247
KEYBOARD	USB KEYBOARD KU-0355 NORWEGIAN VER. 105KS JPN ABS(WITH EKEY VISTA) ROHS	KU-0355	KB.KUS03.248
KEYBOARD	USB KEYBOARD KU-0355 HEBREW VER. 104KS JPN ABS(WITH EKEY VISTA) ROHS	KU-0355	KB.KUS03.249
KEYBOARD	USB KEYBOARD KU-0355 POLISH VER. 105KS JPN ABS(WITH EKEY VISTA) ROHS	KU-0355	KB.KUS03.250
KEYBOARD	USB KEYBOARD KU-0355 SLOVENIAN VER. 105KS JPN ABS(WITH EKEY VISTA) ROHS	KU-0355	KB.KUS03.251
KEYBOARD	USB KEYBOARD KU-0355 SLOVAKIAN VER. 105KS JPN ABS(WITH EKEY VISTA) ROHS	KU-0355	KB.KUS03.252
KEYBOARD	USB KEYBOARD KU-0355 TURKEY VER. 105KS JPN ABS(WITH EKEY VISTA) ROHS	KU-0355	KB.KUS03.253

**Aspire M3600**

<b>CATEGORY</b>	<b>PARTNAME</b>	<b>DESCRIPTION</b>	<b>ACER PART NO.</b>
KEYBOARD	USB KEYBOARD KU-0355 RUSSIAMVER. 104KS JPN ABS(WITH EKEY VISTA) ROHS	KU-0355	KB.KUS03.254
KEYBOARD	USB KEYBOARD KU-0355 HUNGARIA VER. 105KS JPN ABS(WITH EKEY VISTA) ROHS	KU-0355	KB.KUS03.255
KEYBOARD	USB KEYBOARD KU-0355 GREEK VER. 104KS JPN ABS(WITH EKEY VISTA) ROHS	KU-0355	KB.KUS03.256
KEYBOARD	USB KEYBOARD KU-0355 DENMARK VER. 104KS JPN ABS(WITH EKEY VISTA) ROHS	KU-0355	KB.KUS03.257
KEYBOARD	USB KEYBOARD KU-0355 CZECH VER. 104KS JPN ABS(WITH EKEY VISTA) ROHS	KU-0355	KB.KUS03.258
KEYBOARD	USB KEYBOARD KU-0355 ITALIAN NEW LAYOUT 105KS JPN ABS(WITH EKEY VISTA) ROHS	KU-0355	KB.KUS03.259
KEYBOARD	USB KEYBOARD KU-0355 ROMANIAN VER. 105KS JPN ABS(WITH EKEY VISTA) ROHS	KU-0355	KB.KUS03.260
KEYBOARD	USB KEYBOARD KU-0355 TURKEY/FRENCH VER. 105KS JPN ABS(WITH EKEY VISTA) ROHS	KU-0355	KB.KUS03.261
KEYBOARD	USB KEYBOARD KU-0355 FRENCH+ARABIC 105KS (WITH EKEY VISTA) ROHS	KU-0355	KB.KUS03.263
KEYBOARD	USB KEYBOARD SK-9610 US VER. 104KS(WITH EKEY VISTA) ROHS	SK-9610	KB.9610B.045
KEYBOARD	USB KEYBOARD SK-9610 T.CHINESE VER. 104KS(WITH EKEY VISTA) ROHS	SK-9610	KB.9610B.046
KEYBOARD	USB KEYBOARD SK-9610 S.CHINESE 104KS(WITH EKEY VISTA) ROHS	SK-9610	KB.9610B.047
KEYBOARD	USB KEYBOARD SK-9610 IN'L US VER. 104KS(WITH EKEY VISTA) ROHS	SK-9610	KB.9610B.048
KEYBOARD	USB KEYBOARD SK-9610 ARABIC VER. 104KS(WITH EKEY VISTA) ROHS	SK-9610	KB.9610B.049



**Aspire M3600**

<b>CATEGORY</b>	<b>PARTNAME</b>	<b>DESCRIPTION</b>	<b>ACER PART NO.</b>
KEYBOARD	USB KEYBOARD SK-9610 THAI VER. 104KS(WITH EKEY VISTA) ROHS	SK-9610	KB.9610B.050
KEYBOARD	USB KEYBOARD SK-9610 SPANISH VER. 105KS(WITH EKEY VISTA) ROHS	SK-9610	KB.9610B.051
KEYBOARD	USB KEYBOARD SK-9610 PORTUGESE VER. 105KS(WITH EKEY VISTA) ROHS	SK-9610	KB.9610B.052
KEYBOARD	USB KEYBOARD SK-9610 CANADIAN/FRENCH VER. 105KS(WITH EKEY VISTA) ROHS	SK-9610	KB.9610B.053
KEYBOARD	USB KEYBOARD SK-9610 BRAZILIAN VER. 107KS(WITH EKEY VISTA) ROHS	SK-9610	KB.9610B.054
KEYBOARD	USB KEYBOARD SK-9610 JPNESE 109KS(WITH EKEY VISTA) ROHS	SK-9610	KB.9610B.055
KEYBOARD	USB KEYBOARD SK-9610 GERMANY VER. 105KS (WITH EKEY VISTA) ROHS	SK-9610	KB.9610B.056
KEYBOARD	USB KEYBOARD SK-9610 ITALIAN VER. 105KS (WITH EKEY VISTA) ROHS	SK-9610	KB.9610B.057
KEYBOARD	USB KEYBOARD SK-9610 FRENCH VER. 105KS (WITH EKEY VISTA) ROHS	SK-9610	KB.9610B.058
KEYBOARD	USB KEYBOARD SK-9610 SWEDEN VER. 105KS (WITH EKEY VISTA) ROHS	SK-9610	KB.9610B.059
KEYBOARD	USB KEYBOARD SK-9610 UK VER. 105KS (WITH EKEY VISTA) ROHS	SK-9610	KB.9610B.060
KEYBOARD	USB KEYBOARD SK-9610 DUTCH VER. 105KS (WITH EKEY VISTA) ROHS	SK-9610	KB.9610B.061
KEYBOARD	USB KEYBOARD SK-9610 SWISS VER. 105KS (WITH EKEY VISTA) ROHS	SK-9610	KB.9610B.062
KEYBOARD	USB KEYBOARD SK-9610 BELGIUM VER. 105KS (WITH EKEY VISTA) ROHS	SK-9610	KB.9610B.063
KEYBOARD	USB KEYBOARD SK-9610 ICELAND VER. 105KS (WITH EKEY VISTA) ROHS	SK-9610	KB.9610B.064
KEYBOARD	USB KEYBOARD SK-9610 NORWEGIAN VER. 105KS (WITH EKEY VISTA) ROHS	SK-9610	KB.9610B.065

**Aspire M3600**

<b>CATEGORY</b>	<b>PARTNAME</b>	<b>DESCRIPTION</b>	<b>ACER PART NO.</b>
KEYBOARD	USB KEYBOARD SK-9610 HEBREW VER. 104KS (WITH EKEY VISTA) ROHS	SK-9610	KB.9610B.066
KEYBOARD	USB KEYBOARD SK-9610 POLISH VER. 105KS (WITH EKEY VISTA) ROHS	SK-9610	KB.9610B.067
KEYBOARD	USB KEYBOARD SK-9610 SLOVENIAN VER. 105KS (WITH EKEY VISTA) ROHS	SK-9610	KB.9610B.068
KEYBOARD	USB KEYBOARD SK-9610 SLOVAKIAN VER. 105KS (WITH EKEY VISTA) ROHS	SK-9610	KB.9610B.069
KEYBOARD	USB KEYBOARD SK-9610 TURKEY Q-TYPE VER. 105KS (WITH EKEY VISTA) ROHS	SK-9610	KB.9610B.070
KEYBOARD	USB KEYBOARD SK-9610 RUSSIAMVER. 104KS (WITH EKEY VISTA) ROHS	SK-9610	KB.9610B.071
KEYBOARD	USB KEYBOARD SK-9610 HUNGARIA VER. 105KS (WITH EKEY VISTA) ROHS	SK-9610	KB.9610B.072
KEYBOARD	USB KEYBOARD SK-9610 GREEK VER. 104KS (WITH EKEY VISTA) ROHS	SK-9610	KB.9610B.073
KEYBOARD	USB KEYBOARD SK-9610 DENMARK VER. 105KS (WITH EKEY VISTA) ROHS	SK-9610	KB.9610B.074
KEYBOARD	USB KEYBOARD SK-9610 CZECH VER. 104KS (WITH EKEY VISTA) ROHS	SK-9610	KB.9610B.075
KEYBOARD	USB KEYBOARD SK-9610 ROMANIAN VER. 105KS (WITH EKEY VISTA) ROHS	SK-9610	KB.9610B.076
KEYBOARD	USB KEYBOARD SK-9610 TURKEY F-TYPE VER. 105KS (WITH EKEY VISTA) ROHS	SK-9610	KB.9610B.077
KEYBOARD	USB KEYBOARD SK-9610 FRENCH+ARABIC 105KS (WITH EKEY VISTA) ROHS	SK-9610	KB.9610B.078
KEYBOARD	USB KEYBOARD SK-9610 SPANISH LATIN VER. 105KS(WITH EKEY VISTA) ROHS	SK-9610	KB.9610B.079
KEYBOARD	USB KEYBOARD SK-9610 ITALIAN VER. S1 105KS (WITH EKEY) ROHS	SK-9610	KB.USB0B.002
KEYBOARD	USB KEYBOARD SK-9610 ITALIAN VER. S1 105KS (WITH EKEY VISTA) ROHS	SK-9610	KB.USB0B.001

**Aspire M3600**

<b>CATEGORY</b>	<b>PARTNAME</b>	<b>DESCRIPTION</b>	<b>ACER PART NO.</b>
KEYBOARD	WIRELESS KB COCOON US VER. 104 KEYS(WITH EKEY VISTA) ROHS	Y-RAJ56A	KB.CCN04.087
KEYBOARD	WIRELESS KB COCOON TC VER. 104 KEYS(WITH EKEY VISTA) ROHS WITH STK LABEL	Y-RAJ56A	KB.CCN04.088
KEYBOARD	WIRELESS KB COCOON INT'L US VER. 105 KEYS(WITH EKEY VISTA) ROHS	Y-RAJ56A	KB.CCN04.089
KEYBOARD	WIRELESS KB COCOON ARABIC VER. 104 KEYS(WITH EKEY VISTA) ROHS	Y-RAJ56A	KB.CCN04.090
KEYBOARD	WIRELESS KB COCOON THAI VER. 104 KEYS(WITH EKEY VISTA) ROHS	Y-RAJ56A	KB.CCN04.091
KEYBOARD	WIRELESS KB COCOON GERMANY VER. 105 KEYS(WITH EKEY VISTA) ROHS	Y-RAJ56A	KB.CCN04.092
KEYBOARD	WIRELESS KB COCOON ITALIAN VER. 105 KEYS(WITH EKEY VISTA) ROHS	Y-RAJ56A	KB.CCN04.093
KEYBOARD	WIRELESS KB COCOON FRENCH VER. 105 KEYS(WITH EKEY VISTA) ROHS	Y-RAJ56A	KB.CCN04.094
KEYBOARD	WIRELESS KB COCOON SWEDEN VER. 105 KEYS(WITH EKEY VISTA) ROHS	Y-RAJ56A	KB.CCN04.095
KEYBOARD	WIRELESS KB COCOON SPANISH VER. 105 KEYS(WITH EKEY VISTA) ROHS	Y-RAJ56A	KB.CCN04.096
KEYBOARD	WIRELESS KB COCOON UK VER. 105 KEYS(WITH EKEY VISTA) ROHS	Y-RAJ56A	KB.CCN04.097
KEYBOARD	WIRELESS KB COCOON SWISS VER. 105 KEYS(WITH EKEY VISTA) ROHS	Y-RAJ56A	KB.CCN04.098
KEYBOARD	WIRELESS KB COCOON BELGIUM VER. 105 KEYS(WITH EKEY VISTA) ROHS	Y-RAJ56A	KB.CCN04.099
KEYBOARD	WIRELESS KB COCOON CZECH VER. 104 KEYS(WITH EKEY VISTA) ROHS	Y-RAJ56A	KB.CCN04.100

**Aspire M3600**

<b>CATEGORY</b>	<b>PARTNAME</b>	<b>DESCRIPTION</b>	<b>ACER PART NO.</b>
KEYBOARD	WIRELESS KB COCOON RUSSIAN VER. 105 KEYS(WITH EKEY VISTA) ROHS	Y-RAJ56A	KB.CCN04.101
KEYBOARD	WIRELESS KB COCOON DENMARK VER. 105 KEYS(WITH EKEY VISTA) ROHS	Y-RAJ56A	KB.CCN04.102
KEYBOARD	WIRELESS KB COCOON DUTCH VER. 105 KEYS(WITH EKEY VISTA) ROHS	Y-RAJ56A	KB.CCN04.103
KEYBOARD	WIRELESS KB COCOON PORTUGESE VER. 105 KEYS(WITH EKEY VISTA) ROHS	Y-RAJ56A	KB.CCN04.104
KEYBOARD	WIRELESS KB COCOON SLOVAK VER. 105 KEYS(WITH EKEY VISTA) ROHS	Y-RAJ56A	KB.CCN04.105
KEYBOARD	WIRELESS KB COCOON ICELAND VER. 105 KEYS(WITH EKEY VISTA) ROHS	Y-RAJ56A	KB.CCN04.106
KEYBOARD	WIRELESS KB COCOON NORWEGIAN VER. 105 KEYS(WITH EKEY VISTA) ROHS	Y-RAJ56A	KB.CCN04.107
KEYBOARD	WIRELESS KB COCOON HEBREW VER. 105 KEYS(WITH EKEY VISTA) ROHS	Y-RAJ56A	KB.CCN04.108
KEYBOARD	WIRELESS KB COCOON POLISH VER. 105 KEYS(WITH EKEY VISTA) ROHS	Y-RAJ56A	KB.CCN04.109
KEYBOARD	WIRELESS KB COCOON SLOVENIAN VER. 105 KEYS(WITH EKEY VISTA) ROHS	Y-RAJ56A	KB.CCN04.110
KEYBOARD	WIRELESS KB COCOON TURKEY VER. 105 KEYS(WITH EKEY VISTA) ROHS	Y-RAJ56A	KB.CCN04.111
KEYBOARD	WIRELESS KB COCOON HUNGARIA VER. 105 KEYS(WITH EKEY VISTA) ROHS	Y-RAJ56A	KB.CCN04.112
KEYBOARD	WIRELESS KB COCOON GREEK VER. 104 KEYS(WITH EKEY VISTA) ROHS	Y-RAJ56A	KB.CCN04.113
KEYBOARD	WIRELESS KB COCOON CANADIAN/FRENCH VER. 105 KEYS(WITH EKEY VISTA) ROHS	Y-RAJ56A	KB.CCN04.114

**Aspire M3600**

CATEGORY	PARTNAME	DESCRIPTION	ACER PART NO.
MAINBOARD	MB 946GZ(C2)+ICH7DH RM 1394 ECS	MB 946GZ(C2)+ICH7DH RM 1394 ECS	MB.P3709.020
MEMORY	SAMSUNG DDR2 667 1GB M378T2953EZ3-CE6 ROHS	M378T2953EZ3-CE6	KN.1GB0B.013
MEMORY	"DDRII667 512MB GU34512AJEPN692C4GG, ROHS(NEW PCB)"	GU34512AJEPN692C4 GG	KN.5120H.007
MEMORY	PROMOS DDRII 667 512MB V916764K24QBFW-F5	V916764K24QBFW-F5	KN.5120M.001
MEMORY	UNB-DIMM DDRII 667 512MB NT512T64U88B0BY-3C LF 0.09UM	NT512T64U88B0BY-3C	KN.51203.034
MEMORY	"DDRII667 1GB GU341G0AJEPN692C4GG, ROHS(NEW PCB)"	GU341G0AJEPN692C4 GG	KN.1GB0H.005
MEMORY	NANYA UNB-DIMM DDRII 667 1GB NT1GT64U8HB0BY-3CLF 0.09UM	NT1GT64U8HB0BY-3C	KN.1GB03.017
MEMORY	HYNIX DDR2 667 1GB HYMP512U64CP8-Y5 PQ (UDIMM)	HYMP512U64CP8-Y5	KN.1GB0G.007
SPEAKER	"JS 2.0 SPEAKER, USB, M-1118B, ACER LOGO,ROHS"	SPEAKER.1W..2CH..M 1118B..W/ACER LOGO.USB2.0..LEAD-FREE.JAZZ	SP.11805.003
POWER SUPPLY	"DELTA 250W DPS-250AB-22B, NON-PFC"	"DELTA 250W DPS-250AB-22B, NON-PFC"	PY.25009.001
POWER SUPPLY	DELTA DPS-250AB-22A (PFC) POWER SUPPLY (250W)	DPS-250AB-22A	PY.25009.002
POWER SUPPLY	"FSP 250-50GLV, ROHS 9PA250A007"	FSP 250-50GLV	PY.25008.014

**Aspire M5600**

<b>CATEGORY</b>	<b>PARTNAME</b>	<b>DESCRIPTION</b>	<b>ACER PART NO.</b>
BOARD	USB BOARD	USB BOARD	55.S950A.001
BOARD	POWER SWITCH DB	POWER SWITCH DB	55.P22VF.002
CARD READERS	"CARD READER+1394+IR CR503U2 W/I HOUSING, W/I 1394 CABLE+USB CABLE KYE"	CR503U2	PZ.CR50J.003
CARD READERS	"USB1.1, 9 IN4 W/ONE USB PORT 3.5"" LONG BAY READER GLF-680-070-126"	GLF-680-070-126	PZ.CR90K.002
CARD READERS	"3.5"" USB1.1 9-IN-1 CARD READER, WITH USB CABLE , WITH IMPROVED USB CONNECTOR,SUPPORT USB2.0"	NEW CR126	CR.10400.002
CABLE	"USB CABLE, 610MM"	"USB CABLE, 610MM"	50.S950A.001
CABLE	"AUDIO CABLE, 720MM"	"AUDIO CABLE, 720MM"	50.S950A.002
CABLE	LED CABLE	LED CABLE. 520MM	50.S950A.003
CABLE	FRONT PANEL CABLE. 4PINS	FRONT PANEL CABLE. 4PINS	50.S950A.004
CABLE	ODD CABLE	ODD CABLE	50.S46VF.008
CABLE	SERIAL ATA DATE CABLE	SERIAL ATA DATE CABLE	50.S46VF.001
CABLE	SERIAL ATA DATA CABLE FOR ODD	SERIAL ATA DATA CABLE FOR ODD	50.P40VF.003
CABLE	SARIAL ATA POWER CABLE	SARIAL ATA POWER CABLE	50.P37VF.002
CABLE	FDD CABLE	FDD CABLE	50.S46VF.007
CABLE	SPDIF CABLE	SPDIF CABLE	55.S46VF.003
CASE/COVER/BACKET ASSEMBLY	I/O SHIELD	I/O SHIELD ASSY	PZ.P2204.003
CASE/COVER/BACKET ASSEMBLY	H402 BASIC CHASSIS W/ SIDE DOORS W/O BEZEL AND TOP-COVER (PAINTED)	H402 BASIC CHASSIS W/ SIDE DOORS W/O BEZEL AND TOP-COVER (PAINTED)	60.S950A.001
CASE/COVER/BACKET ASSEMBLY	HARD AS IRON TOP-COVER (PAINTED)	HARD AS IRON TOP- COVER (PAINTED)	60.S950A.002
CASE/COVER/BACKET ASSEMBLY	USB HOLDER ASSY	USB HOLDER ASSY	33.S950A.001
CASE/COVER/BACKET ASSEMBLY	RIGHT-SIDE COVER (PAINTED)	RIGHT-SIDE COVER (PAINTED)	60.S950A.003

**Aspire M5600**

<b>CATEGORY</b>	<b>PARTNAME</b>	<b>DESCRIPTION</b>	<b>ACER PART NO.</b>
CASE/COVER/BRACKET ASSEMBLY	LEFT-SIDE COVER (PAINTED)	LEFT-SIDE COVER (PAINTED)	60.S950A.004
CASE/COVER/BRACKET ASSEMBLY	PLASTICE TOP COVER	PLASTICE TOP COVER	42.S950A.001
CASE/COVER/BRACKET ASSEMBLY	USB MYLAR	USB MYLAR	47.S950A.001
CASE/COVER/BRACKET ASSEMBLY	AM500 BEZEL W/I POWER BUTTON_FDODDCOVER_ACERLOGO_LED CABLE_POWER SWITCH DB	AM500 BEZEL W/I POWER BUTTON_FDODDCOVER_ACERLOGO_LED CABLE_POWER SWITCH DB	60.S970F.001
CASE/COVER/BRACKET ASSEMBLY	FDD COVER FOR AM10 30 50 BEZEL	FDD COVER FOR AM10 30 50 BEZEL	42.S950A.002
CASE/COVER/BRACKET ASSEMBLY	ACER LOGO	ACER LOGO	47.P35VF.001
ADD-ON CARD	"SP RADEON X1550 512MB HM (ONBOARD 64MB) DDR2(HYNIX) 32-BITS VGA+DVI-I+TVO PAL W/ATX BKT,88-DC92-0C-AC,ROHS"	88-DC92-0C-AC	54.X1550.H31
ADD-ON CARD	"SP RADEON X1550 512MB HM (ONBOARD 64MB) DDR2(HYNIX) 32-BITS VGA+DVI-I+TVO NTSC W/ATX BKT,88-DC92-0C-AC,ROHS"	88-DC92-0C-AC	54.X1550.H32
ADD-ON CARD	"SP ATI RADEON X1650SE 512MB HM ONBOARD 256M 64BIT DDR2(HYNIX) VGA+TVO+DVI-I PAL W/ATX BKT, 88-9C92-0C-AC, ROHS"	88-9C92-0C-AC	54.X1650.S01
ADD-ON CARD	"LIFEVIEW DUAL TV TUNER CARD W/I(ATX/FM ANTENNA/AV IN CABLE/ PAL-NTSC CONVERTOR/ DVB-T ANTENNA),REV C,ROHS"	"HYBRID TV CARD LR306N ( W.W. ANALOG TV / DVB-T )W/I FM, INCLUDING FM ANTENNA"	TU.30605.005
ADD-ON CARD	WINTV-HVR1110 DVB-T PAL OXFORD2 67559 REV B1B4	WINTV-HVR-1110	TV.HAUOX.BT2
ADD-ON CARD	"PRONET PCI MODEM CARD HPI56M3F W/ATX BKT, ROHS"	"PRO-NETS PCI MODEM CARD W/ AUS REGULATORY LABEL,HPI56M3F,ATX,ROHS,FOR WORDWIDE"	FX.56M03.003
ADD-ON CARD	D-1156I#/A7A	D-1156I#/A7A	FX.15602.001

**Aspire M5600**

CATEGORY	PARTNAME	DESCRIPTION	ACER PART NO.
ADD-ON CARD	VGA CARD.ATI RADEON X1550 HM.512MB 64B..(BUY-ACER).VGA+DVI-I+TVO PAL...W/ATX BKT	VGA CARD.ATI RADEON X1550 HM.512MB 64B..(BUY-ACER).VGA+DVI-I+TVO PAL...W/ATX BKT	54.X1550.H41
ADD-ON CARD	"PC PARTNER GEFORCE 7500LE TC 512MB ON-BOARD 128MB/64BIT DDR2 (HYNIX) VGA+TVO+DVI-I PAL W/ATX BKT,88-4N01-2C-AC, ROHS,"	88-4N01-2C-AC	VG.PC75L.E15
DVD RW DRIVE	"HLDS DVD-DUAL GSA-H21N, LF , DASP, SIP 5.0 , NEW BEZEL, FOR VISTA, F/W:1.01"	GSA-H21N	KU.0160D.024
DVD RW DRIVE	"HLDS SATA DVD-DUAL GSA-H31N LF , SATA , SIP 5.0 , NEW BEZEL , F/W: 1.01, FOR VISTA"	GSA-H31N	KU.0160D.025
DVD RW DRIVE	"LITE-ON 16X DVD-DUAL DH-16W1P PATA , F/W: LA11, ROHS"	DH-16W1P	KU.01609.001
DVD RW DRIVE	"HLDS 16X DVD-DUAL GSA-H41N, F/W: RA00,ROHS"	GSA-H41N	KU.0160D.030
DVD RW DRIVE	"16X SUPERMULTI MODEL:DH-16A1P,ROHS F/W RA11"	DH-16A1P	KU.01609.003
DVD RW DRIVE	16X SUPER MULITI GSA-H40N LF	GSA-H40N	KU.0160D.029
COMBO MODULE	"LITE-ON COMBO DH-52C1P ROHS, F/W: KA11"	DH-52C1P	KO.05209.013
CPU/PROCESSES	CPU E6420 2.13G/4M/1066FSB B2 R	CPU E6420 2.13G/4M/1066FSB B2 R	KC.64201.DE0
CPU/PROCESSES	CORE 2 DUO E6400 (2.13G 2M 1066FSB) L2	E6400	KC.64001.DEL
CPU/PROCESSOR	CORE 2 DUO E6600 (2.4G 4M 1066FSB) B2	HH80557PH0564M	KC.66001.DE0
CPU/PROCESSOR	CPU CORE 2 DUO E6300 1.86G/2M/1066 R	CPU CORE 2 DUO E6300 1.86G/2M/1066 R	KC.63001.DEL
CPU/PROCESSOR	CONROE E6400	C2DE6400	KC.64001.DE0
CPU/PROCESSOR	CORE 2 DUO E6300 (1.86G 2M 1066FSB)	HH80557PH0362M	KC.63001.DE0
CPU/PROCESSOR	CORE 2 DUO E4400(2.0G 2M 800FSB)L2	C2DE4400	KC.44001.DE0



**Aspire M5600**

CATEGORY	PARTNAME	DESCRIPTION	ACER PART NO.
CPU/PROCESSOR	CORE 2 DUO E4300(1.8G 2M 800FSB)L2	C2DE4300	KC.43001.DE0
CPU/PROCESSOR	CPU PENTIUM DUAL CORE E2160 1.8G/1M/800	CPU PENTIUM DUAL CORE E2160 1.8G/1M/800	KC.21601.DEP
CPU/PROCESSOR	P4 641 (3.2G 2M 800FSB)D0	641	KC.DD001.641
CPU/PROCESSOR	CELERON D 356 (3.3G 512K 533FSB LGA775) D-0	HH80552RE093512	KC.DD001.356
CPU/PROCESSOR	CELERON D 352 (3.2G 512K 533FSB LGA775) D-0	HH80552RE088512	KC.DD001.352
FAN SINK	CPU COOLER THERMALFLY V2.0 ROHS	P300L	HI.P300L.001
FAN SINK	PKP367G01U12(WITH SUNON 9225 4200RPM FAN)	PKP367G01U12	HI.3670C.001
FDD/FLOPPY DISK DRIVE	FDD 1.44MB PANASONIC JU-256A048P BLACK	"FDD,PANASONIC,JU-256A048P BLACK"	KF.25602.003
HDD/HARD DISK DRIVE	"SEAGATE SATA2 TONKA2 160G 7200RPM 8M W/NCQ ST3160812AS, ROHS SSC OFF"	ST3160812AS	KH.16001.028
HDD/HARD DISK DRIVE	"SEAGATE GALAXY 250G SATAII 7200RPM 8MB,W/NCQ ST3250820AS ROHS SSC OFF"	ST3250820AS	KH.25001.008
HDD/HARD DISK DRIVE	"SEAGATE GALAXY 320G SATAII 7200RPM 8MB,W/NCQ ST3320820AS ROHS SSC OFF"	ST3320820AS	KH.32001.007
HDD/HARD DISK DRIVE	"HITACHI PATHFINDER2 160G 7200RPM HDS721616PLA380, W/NCQ, ROHS"	HDS721616PLA380	KH.16007.012
HDD/HARD DISK DRIVE	"WD 80G XL80SIII SATA2 7200RPM 8M WD800JD-22MSA1 W/NCQ, ROHS"	"VANCOUVER V, HDT725025VLA380"	KH.25007.009
HDD/HARD DISK DRIVE	"320GB HDT725032VLA380 SATAII 8M,ROHS"	HDT725032VLA380	KH.32007.001
HDD/HARD DISK DRIVE	"WD 250G SATA2 WD2500AAJS-22RYA0 3G 8MB LF W/NCQ,ROHS"	WD2500AAJS-22RYA0	KH.25008.017
HDD/HARD DISK DRIVE	"320G SATA2 WD3200AAJS-22RYA0 3G 8MB LF W/ NCQ,ROHS"	XL160M WD3200AAJS-22RYA0	KH.32008.011
POINTING DEVICE	PS2 OPTICAL MOUSE LF VERSION LOGITECH M-SBF96	LOGITECH M-SBF96 PS2 OPTICAL MOUSE LF VERSION	MS.PS201.002

**Aspire M5600**

<b>CATEGORY</b>	<b>PARTNAME</b>	<b>DESCRIPTION</b>	<b>ACER PART NO.</b>
POINTING DEVICE	WIRELESS RECEIVER LOGITECH	"USB RF RECEIVER, GUPPY, W/I CASE, ROHS"	RV.GPY01.006
POINTING DEVICE	"WIRELESS MOUSE, M- RAU95, ROHS LOGITECH"	"LOGITECH WIRELESS MOUSE, M-RAU95, ROHS"	MS.RAF01.004
POINTING DEVICE	"LOGITECH USB OPTICAL MOUSE, MUV ACR1, (ROHS), W/ STK LABEL"	"M-UV ACR1 (BLACK), (ROHS)"	MS.MUV01.005
KEYBOARD	"PS/2 KEYBOARD SK1688 T.CHINESE VER. 104KEYS(WITH EKEY VISTA), NON-ROHS"	SK1688	KB.6880B.042
KEYBOARD	PS/2 KEYBOARD SK1688 THAI VER. 104KEYS(WITH EKEY VISTA) ROHS	SK1688	KB.6880B.043
KEYBOARD	PS/2 KEYBOARD SK1688 T.CHINESE VER. 104KEYS(WITH EKEY VISTA) ROHS	SK1688	KB.6880B.044
KEYBOARD	PS/2 KEYBOARD SK1688 EN VER. 104KEYS(WITH EKEY VISTA) ROHS	SK1688	KB.6880B.045
KEYBOARD	PS/2 KEYBOARD SK1688 CAFR VER. 105KEYS(WITH EKEY VISTA) ROHS	SK1688	KB.6880B.046
KEYBOARD	PS/2 KEYBOARD SK1688 SPANISH VER. 105KEYS(WITH EKEY VISTA) ROHS	SK1688	KB.6880B.047
KEYBOARD	PS2 KEYBOARD SK1688 IN'L US VER. 104KS(WITH EKEY VISTA) ROHS	SK1688	KB.6880B.048
KEYBOARD	PS/2 KEYBOARD SK1688 SPANISH LATIN VER. 105KEYS(WITH EKEY VISTA) ROHS	SK1688	KB.6880B.049
KEYBOARD	PS/2 KEYBOARD SK1688 GERMANY VER. 105KEYS(WITH EKEY VISTA) WHITE ROHS	SK1688	KB.6880B.050
KEYBOARD	PS/2 KEYBOARD SK1688 ARABIC + US VER. 104KS(WITH EKEY VISTA) ROHS	SK1688	KB.6880B.051
KEYBOARD	PS/2 KEYBOARD SK1688 PORTUGESE VER. 105KS(WITH EKEY VISTA) ROHS	SK1688	KB.6880B.052

**Aspire M5600**

<b>CATEGORY</b>	<b>PARTNAME</b>	<b>DESCRIPTION</b>	<b>ACER PART NO.</b>
KEYBOARD	PS/2 KEYBOARD SK1688 BRAZILIAN VER. 107KS(WITH EKEY VISTA) ROHS	SK1688	KB.6880B.053
KEYBOARD	PS/2 KEYBOARD SK1688 JPNESE 109KS(WITH EKEY VISTA) ROHS	SK1688	KB.6880B.054
KEYBOARD	PS/2 KEYBOARD SK1688 GERMANY VER. 105KS (WITH EKEY VISTA) ROHS	SK1688	KB.6880B.055
KEYBOARD	PS/2 KEYBOARD SK1688 ITALIAN VER. 105KS (WITH EKEY VISTA) ROHS	SK1688	KB.6880B.056
KEYBOARD	PS/2 KEYBOARD SK1688 FRENCH VER. 105KS (WITH EKEY VISTA) ROHS	SK1688	KB.6880B.057
KEYBOARD	PS/2 KEYBOARD SK1688 SWEDEN VER. 105KS (WITH EKEY VISTA) ROHS	SK1688	KB.6880B.058
KEYBOARD	PS/2 KEYBOARD SK1688 UK VER. 105KS (WITH EKEY VISTA) ROHS	SK1688	KB.6880B.059
KEYBOARD	PS/2 KEYBOARD SK1688 DUTCH VER. 105KS (WITH EKEY VISTA) ROHS	SK1688	KB.6880B.060
KEYBOARD	PS/2 KEYBOARD SK1688 SWISS VER. 105KS (WITH EKEY VISTA) ROHS	SK1688	KB.6880B.061
KEYBOARD	PS/2 KEYBOARD SK1688 BELGIUM VER. 105KS (WITH EKEY VISTA) ROHS	SK1688	KB.6880B.062
KEYBOARD	PS/2 KEYBOARD SK1688 ICELAND VER. 105KS (WITH EKEY VISTA) ROHS	SK1688	KB.6880B.063
KEYBOARD	PS/2 KEYBOARD SK1688 NORWEGIAN VER. 105KS (WITH EKEY VISTA) ROHS	SK1688	KB.6880B.064
KEYBOARD	PS/2 KEYBOARD SK1688 HEBREW VER. 104KS (WITH EKEY VISTA) ROHS	SK1688	KB.6880B.065
KEYBOARD	PS/2 KEYBOARD SK1688 POLISH VER. 105KS (WITH EKEY VISTA) ROHS	SK1688	KB.6880B.066
KEYBOARD	PS/2 KEYBOARD SK1688 SLOVENIAN VER. 105KS (WITH EKEY VISTA) ROHS	SK1688	KB.6880B.067
KEYBOARD	PS/2 KEYBOARD SK1688 SLOVAKIAN VER. 105KS (WITH EKEY VISTA) ROHS	SK1688	KB.6880B.068

**Aspire M5600**

<b>CATEGORY</b>	<b>PARTNAME</b>	<b>DESCRIPTION</b>	<b>ACER PART NO.</b>
KEYBOARD	PS/2 KEYBOARD SK1688 TURKISH Q-TYPE VER. 105KS (WITH EKEY VISTA) ROHS	SK1688	KB.6880B.069
KEYBOARD	PS/2 KEYBOARD SK1688 RUSSIAMVER. 104KS (WITH EKEY VISTA) ROHS	SK1688	KB.6880B.070
KEYBOARD	PS/2 KEYBOARD SK1688 HUNGARIA VER. 105KS (WITH EKEY VISTA) ROHS	SK1688	KB.6880B.071
KEYBOARD	PS/2 KEYBOARD SK1688 GREEK VER. 104KS (WITH EKEY VISTA) ROHS	SK1688	KB.6880B.072
KEYBOARD	PS/2 KEYBOARD SK1688 DENMARK VER. 104KS (WITH EKEY VISTA) ROHS	SK1688	KB.6880B.073
KEYBOARD	PS/2 KEYBOARD SK1688 CZECH VER. 104KS (WITH EKEY VISTA) ROHS	SK1688	KB.6880B.074
KEYBOARD	PS/2 KEYBOARD SK1688 ROMANIAN VER. 105KS (WITH EKEY VISTA) ROHS	SK1688	KB.6880B.075
KEYBOARD	PS/2 KEYBOARD SK1688 TURKEY F-TYPE VER. 105KS (WITH EKEY VISTA) ROHS	SK1688	KB.6880B.076
KEYBOARD	PS/2 KEYBOARD SK1688 FRENCH+ARABIC 105KS (WITH EKEY VISTA) ROHS	SK1688	KB.6880B.077
KEYBOARD	PS/2 KEYBOARD SK1688 ITALIAN VER S1. 105KS (WITH EKEY) ROHS	SK1688	KB.PS20B.002
KEYBOARD	PS/2 KEYBOARD SK1688 ITALIAN VER S1. 105KS (WITH EKEY VISTA) ROHS	SK1688	KB.PS20B.001
KEYBOARD	USB KEYBOARD KU-0355 US VER. 104KS(WITH EKEY VISTA) ROHS	KU-0355	KB.KUS03.222
KEYBOARD	USB KEYBOARD KU-0355 T.CHINESE VER. 104KS(WITH EKEY VISTA) ROHS	KU-0355	KB.KUS03.223
KEYBOARD	USB KEYBOARD KU-0355 S.CHINESE 104KS(WITH EKEY VISTA) ROHS	KU-0355	KB.KUS03.224
KEYBOARD	USB KEYBOARD KU-0355 IN'L US VER. 104KS(WITH EKEY VISTA) ROHS	KU-0355	KB.KUS03.225
KEYBOARD	USB KEYBOARD KU-0355 ARABIC VER. 104KS(WITH EKEY VISTA) ROHS	KU-0355	KB.KUS03.226

**Aspire M5600**

<b>CATEGORY</b>	<b>PARTNAME</b>	<b>DESCRIPTION</b>	<b>ACER PART NO.</b>
KEYBOARD	USB KEYBOARD KU-0355 THAI VER. 104KS(WITH EKEY VISTA) ROHS	KU-0355	KB.KUS03.227
KEYBOARD	USB KEYBOARD KU-0355 SPANISH VER. 105KS(WITH EKEY VISTA) ROHS	KU-0355	KB.KUS03.228
KEYBOARD	USB KEYBOARD KU-0355 CANADIAN/FRENCH VER. 105KS(WITH EKEY VISTA) ROHS	KU-0355	KB.KUS03.230
KEYBOARD	USB KEYBOARD KU-0355 BRAZILIAN VER. 107KS(WITH EKEY VISTA) ROHS	KU-0355	KB.KUS03.231
KEYBOARD	USB KEYBOARD KU-0355 JPNESE 109KS(WITH EKEY VISTA) ROHS	KU-0355	KB.KUS03.232
KEYBOARD	USB KEYBOARD KU-0355 FRENCH VER. 105KEYS (WITH EKEY VISTA) ROHS	KU-0355	KB.KUS03.262
KEYBOARD	USB KEYBOARD KU-0355 SPANISH LATIN VER. 105KS(WITH EKEY VISTA) ROHS	KU-0355	KB.KUS03.264
KEYBOARD	USB KEYBOARD KU-0355 US VER. 104KS JPN ABS(WITH EKEY VISTA) ROHS	KU-0355	KB.KUS03.233
KEYBOARD	USB KEYBOARD KU-0355 IN'L US VER. 104KS JPN ABS(WITH EKEY VISTA) ROHS	KU-0355	KB.KUS03.234
KEYBOARD	USB KEYBOARD KU-0355 ARABIC VER. 104KS JPN ABS(WITH EKEY VISTA) ROHS	KU-0355	KB.KUS03.235
KEYBOARD	USB KEYBOARD KU-0355 GERMANY VER. 105KS JPN ABS(WITH EKEY VISTA) ROHS	KU-0355	KB.KUS03.236
KEYBOARD	USB KEYBOARD KU-0355 ITALIAN VER. 105KS JPN ABS(WITH EKEY VISTA) ROHS	KU-0355	KB.KUS03.237
KEYBOARD	USB KEYBOARD KU-0355 FRENCH VER. 105KS JPN ABS(WITH EKEY VISTA) ROHS	KU-0355	KB.KUS03.238
KEYBOARD	USB KEYBOARD KU-0355 SWEDEN VER. 105KS JPN ABS(WITH EKEY VISTA) ROHS	KU-0355	KB.KUS03.239

**Aspire M5600**

<b>CATEGORY</b>	<b>PARTNAME</b>	<b>DESCRIPTION</b>	<b>ACER PART NO.</b>
KEYBOARD	USB KEYBOARD KU-0355 UK VER. 105KS JPN ABS(WITH EKEY VISTA) ROHS	KU-0355	KB.KUS03.240
KEYBOARD	USB KEYBOARD KU-0355 SPANISH VER. 105KS JPN ABS(WITH EKEY VISTA) ROHS	KU-0355	KB.KUS03.241
KEYBOARD	USB KEYBOARD KU-0355 DUTCH VER. 105KS JPN ABS(WITH EKEY VISTA) ROHS	KU-0355	KB.KUS03.242
KEYBOARD	USB KEYBOARD KU-0355 PORTUGUESE VER. 105KS JPN ABS(WITH EKEY VISTA) ROHS	KU-0355	KB.KUS03.243
KEYBOARD	USB KEYBOARD KU-0355 SWISS VER. 105KS JPN ABS(WITH EKEY VISTA) ROHS	KU-0355	KB.KUS03.244
KEYBOARD	USB KEYBOARD KU-0355 BELGIUM VER. 105KS JPN ABS(WITH EKEY VISTA) ROHS	KU-0355	KB.KUS03.245
KEYBOARD	USB KEYBOARD KU-0355 ICELAND VER. 105KS JPN ABS(WITH EKEY VISTA) ROHS	KU-0355	KB.KUS03.247
KEYBOARD	USB KEYBOARD KU-0355 NORWEGIAN VER. 105KS JPN ABS(WITH EKEY VISTA) ROHS	KU-0355	KB.KUS03.248
KEYBOARD	USB KEYBOARD KU-0355 HEBREW VER. 104KS JPN ABS(WITH EKEY VISTA) ROHS	KU-0355	KB.KUS03.249
KEYBOARD	USB KEYBOARD KU-0355 POLISH VER. 105KS JPN ABS(WITH EKEY VISTA) ROHS	KU-0355	KB.KUS03.250
KEYBOARD	USB KEYBOARD KU-0355 SLOVENIAN VER. 105KS JPN ABS(WITH EKEY VISTA) ROHS	KU-0355	KB.KUS03.251
KEYBOARD	USB KEYBOARD KU-0355 SLOVAKIAN VER. 105KS JPN ABS(WITH EKEY VISTA) ROHS	KU-0355	KB.KUS03.252
KEYBOARD	USB KEYBOARD KU-0355 TURKEY VER. 105KS JPN ABS(WITH EKEY VISTA) ROHS	KU-0355	KB.KUS03.253

**Aspire M5600**

<b>CATEGORY</b>	<b>PARTNAME</b>	<b>DESCRIPTION</b>	<b>ACER PART NO.</b>
KEYBOARD	USB KEYBOARD KU-0355 RUSSIAMVER. 104KS JPN ABS(WITH EKEY VISTA) ROHS	KU-0355	KB.KUS03.254
KEYBOARD	USB KEYBOARD KU-0355 HUNGARIA VER. 105KS JPN ABS(WITH EKEY VISTA) ROHS	KU-0355	KB.KUS03.255
KEYBOARD	USB KEYBOARD KU-0355 GREEK VER. 104KS JPN ABS(WITH EKEY VISTA) ROHS	KU-0355	KB.KUS03.256
KEYBOARD	USB KEYBOARD KU-0355 DENMARK VER. 104KS JPN ABS(WITH EKEY VISTA) ROHS	KU-0355	KB.KUS03.257
KEYBOARD	USB KEYBOARD KU-0355 CZECH VER. 104KS JPN ABS(WITH EKEY VISTA) ROHS	KU-0355	KB.KUS03.258
KEYBOARD	USB KEYBOARD KU-0355 ITALIAN NEW LAYOUT 105KS JPN ABS(WITH EKEY VISTA) ROHS	KU-0355	KB.KUS03.259
KEYBOARD	USB KEYBOARD KU-0355 ROMANIAN VER. 105KS JPN ABS(WITH EKEY VISTA) ROHS	KU-0355	KB.KUS03.260
KEYBOARD	USB KEYBOARD KU-0355 TURKEY/FRENCH VER. 105KS JPN ABS(WITH EKEY VISTA) ROHS	KU-0355	KB.KUS03.261
KEYBOARD	USB KEYBOARD KU-0355 FRENCH+ARABIC 105KS (WITH EKEY VISTA) ROHS	KU-0355	KB.KUS03.263
KEYBOARD	USB KEYBOARD SK-9610 US VER. 104KS(WITH EKEY VISTA) ROHS	SK-9610	KB.9610B.045
KEYBOARD	USB KEYBOARD SK-9610 T.CHINESE VER. 104KS(WITH EKEY VISTA) ROHS	SK-9610	KB.9610B.046
KEYBOARD	USB KEYBOARD SK-9610 S.CHINESE 104KS(WITH EKEY VISTA) ROHS	SK-9610	KB.9610B.047
KEYBOARD	USB KEYBOARD SK-9610 IN'L US VER. 104KS(WITH EKEY VISTA) ROHS	SK-9610	KB.9610B.048
KEYBOARD	USB KEYBOARD SK-9610 ARABIC VER. 104KS(WITH EKEY VISTA) ROHS	SK-9610	KB.9610B.049

**Aspire M5600**

<b>CATEGORY</b>	<b>PARTNAME</b>	<b>DESCRIPTION</b>	<b>ACER PART NO.</b>
KEYBOARD	USB KEYBOARD SK-9610 THAI VER. 104KS(WITH EKEY VISTA) ROHS	SK-9610	KB.9610B.050
KEYBOARD	USB KEYBOARD SK-9610 SPANISH VER. 105KS(WITH EKEY VISTA) ROHS	SK-9610	KB.9610B.051
KEYBOARD	USB KEYBOARD SK-9610 PORTUGUESE VER. 105KS(WITH EKEY VISTA) ROHS	SK-9610	KB.9610B.052
KEYBOARD	USB KEYBOARD SK-9610 CANADIAN/FRENCH VER. 105KS(WITH EKEY VISTA) ROHS	SK-9610	KB.9610B.053
KEYBOARD	USB KEYBOARD SK-9610 BRAZILIAN VER. 107KS(WITH EKEY VISTA) ROHS	SK-9610	KB.9610B.054
KEYBOARD	USB KEYBOARD SK-9610 JPNESE 109KS(WITH EKEY VISTA) ROHS	SK-9610	KB.9610B.055
KEYBOARD	USB KEYBOARD SK-9610 GERMANY VER. 105KS (WITH EKEY VISTA) ROHS	SK-9610	KB.9610B.056
KEYBOARD	USB KEYBOARD SK-9610 ITALIAN VER. 105KS (WITH EKEY VISTA) ROHS	SK-9610	KB.9610B.057
KEYBOARD	USB KEYBOARD SK-9610 FRENCH VER. 105KS (WITH EKEY VISTA) ROHS	SK-9610	KB.9610B.058
KEYBOARD	USB KEYBOARD SK-9610 SWEDEN VER. 105KS (WITH EKEY VISTA) ROHS	SK-9610	KB.9610B.059
KEYBOARD	USB KEYBOARD SK-9610 UK VER. 105KS (WITH EKEY VISTA) ROHS	SK-9610	KB.9610B.060
KEYBOARD	USB KEYBOARD SK-9610 DUTCH VER. 105KS (WITH EKEY VISTA) ROHS	SK-9610	KB.9610B.061
KEYBOARD	USB KEYBOARD SK-9610 SWISS VER. 105KS (WITH EKEY VISTA) ROHS	SK-9610	KB.9610B.062
KEYBOARD	USB KEYBOARD SK-9610 BELGIUM VER. 105KS (WITH EKEY VISTA) ROHS	SK-9610	KB.9610B.063
KEYBOARD	USB KEYBOARD SK-9610 ICELAND VER. 105KS (WITH EKEY VISTA) ROHS	SK-9610	KB.9610B.064
KEYBOARD	USB KEYBOARD SK-9610 NORWEGIAN VER. 105KS (WITH EKEY VISTA) ROHS	SK-9610	KB.9610B.065



**Aspire M5600**

<b>CATEGORY</b>	<b>PARTNAME</b>	<b>DESCRIPTION</b>	<b>ACER PART NO.</b>
KEYBOARD	USB KEYBOARD SK-9610 HEBREW VER. 104KS (WITH EKEY VISTA) ROHS	SK-9610	KB.9610B.066
KEYBOARD	USB KEYBOARD SK-9610 POLISH VER. 105KS (WITH EKEY VISTA) ROHS	SK-9610	KB.9610B.067
KEYBOARD	USB KEYBOARD SK-9610 SLOVENIAN VER. 105KS (WITH EKEY VISTA) ROHS	SK-9610	KB.9610B.068
KEYBOARD	USB KEYBOARD SK-9610 SLOVAKIAN VER. 105KS (WITH EKEY VISTA) ROHS	SK-9610	KB.9610B.069
KEYBOARD	USB KEYBOARD SK-9610 TURKEY Q-TYPE VER. 105KS (WITH EKEY VISTA) ROHS	SK-9610	KB.9610B.070
KEYBOARD	USB KEYBOARD SK-9610 RUSSIAMVER. 104KS (WITH EKEY VISTA) ROHS	SK-9610	KB.9610B.071
KEYBOARD		SK-9610	KB.9610B.072
KEYBOARD	USB Keyboard SK-9610 Greek Ver. 104KS (with eKey Vista) RoHS	SK-9610	KB.9610B.073
KEYBOARD	USB Keyboard SK-9610 Denmark Ver. 105KS (with eKey Vista) RoHS	SK-9610	KB.9610B.074
KEYBOARD	USB Keyboard SK-9610 Czech Ver. 104KS (with eKey Vista) RoHS	SK-9610	KB.9610B.075
KEYBOARD	USB Keyboard SK-9610 Romanian Ver. 105KS (with eKey Vista) RoHS	SK-9610	KB.9610B.076
KEYBOARD	USB Keyboard SK-9610 Turkey F-Type Ver. 105KS (with eKey Vista) RoHS	SK-9610	KB.9610B.077
KEYBOARD	USB Keyboard SK-9610 French+Arabic 105KS (with ekey Vista) RoHS	SK-9610	KB.9610B.078
KEYBOARD	USB Keyboard SK-9610 Spanish Latin Ver. 105KS(with eKey Vista) RoHS	SK-9610	KB.9610B.079
KEYBOARD	USB Keyboard SK-9610 Italian Ver. S1 105KS (with eKey) RoHS	SK-9610	KB.USB0B.002
KEYBOARD	USB Keyboard SK-9610 Italian Ver. S1 105KS (with eKey Vista) RoHS	SK-9610	KB.USB0B.001
KEYBOARD	Wireless KB Cocoon US ver. 104 keys(with eKey Vista) RoHS	Y-RAJ56A	KB.CCN04.087

**Aspire M5600**

<b>CATEGORY</b>	<b>PARTNAME</b>	<b>DESCRIPTION</b>	<b>ACER PART NO.</b>
KEYBOARD	Wireless KB Cocoon TC ver. 104 keys(with eKey Vista) RoHS with STK Label	Y-RAJ56A	KB.CCN04.088
KEYBOARD	Wireless KB Cocoon Int'l US ver. 105 keys(with eKey Vista) RoHS	Y-RAJ56A	KB.CCN04.089
KEYBOARD	Wireless KB Cocoon Arabic ver. 104 keys(with eKey Vista) RoHS	Y-RAJ56A	KB.CCN04.090
KEYBOARD	Wireless KB Cocoon Thai ver. 104 keys(with eKey Vista) RoHS	Y-RAJ56A	KB.CCN04.091
KEYBOARD	Wireless KB Cocoon Germany ver. 105 keys(with eKey Vista) RoHS	Y-RAJ56A	KB.CCN04.092
KEYBOARD	Wireless KB Cocoon Italian ver. 105 keys(with eKey Vista) RoHS	Y-RAJ56A	KB.CCN04.093
KEYBOARD	Wireless KB Cocoon French ver. 105 keys(with eKey Vista) RoHS	Y-RAJ56A	KB.CCN04.094
KEYBOARD	Wireless KB Cocoon Sweden ver. 105 keys(with eKey Vista) RoHS	Y-RAJ56A	KB.CCN04.095
KEYBOARD	Wireless KB Cocoon Spanish ver. 105 keys(with eKey Vista) RoHS	Y-RAJ56A	KB.CCN04.096
KEYBOARD	Wireless KB Cocoon UK ver. 105 keys(with eKey Vista) RoHS	Y-RAJ56A	KB.CCN04.097
KEYBOARD	Wireless KB Cocoon Swiss ver. 105 keys(with eKey Vista) RoHS	Y-RAJ56A	KB.CCN04.098
KEYBOARD	Wireless KB Cocoon Belgium ver. 105 keys(with eKey Vista) RoHS	Y-RAJ56A	KB.CCN04.099
KEYBOARD	Wireless KB Cocoon Czech ver. 104 keys(with eKey Vista) RoHS	Y-RAJ56A	KB.CCN04.100
KEYBOARD	Wireless KB Cocoon Russian ver. 105 keys(with eKey Vista) RoHS	Y-RAJ56A	KB.CCN04.101
KEYBOARD	Wireless KB Cocoon Denmark ver. 105 keys(with eKey Vista) RoHS	Y-RAJ56A	KB.CCN04.102
KEYBOARD	Wireless KB Cocoon Dutch ver. 105 keys(with eKey Vista) RoHS	Y-RAJ56A	KB.CCN04.103
KEYBOARD	Wireless KB Cocoon Portugese ver. 105 keys(with eKey Vista) RoHS	Y-RAJ56A	KB.CCN04.104

**Aspire M5600**

<b>CATEGORY</b>	<b>PARTNAME</b>	<b>DESCRIPTION</b>	<b>ACER PART NO.</b>
KEYBOARD	Wireless KB Cocoon Slovak ver. 105 keys(with eKey Vista) RoHS	Y-RAJ56A	KB.CCN04.105
KEYBOARD	Wireless KB Cocoon Iceland ver. 105 keys(with eKey Vista) RoHS	Y-RAJ56A	KB.CCN04.106
KEYBOARD	Wireless KB Cocoon Norwegian ver. 105 keys(with eKey Vista) RoHS	Y-RAJ56A	KB.CCN04.107
KEYBOARD	Wireless KB Cocoon Hebrew ver. 105 keys(with eKey Vista) RoHS	Y-RAJ56A	KB.CCN04.108
KEYBOARD	Wireless KB Cocoon Polish ver. 105 keys(with eKey Vista) RoHS	Y-RAJ56A	KB.CCN04.109
KEYBOARD	Wireless KB Cocoon Slovenian ver. 105 keys(with eKey Vista) RoHS	Y-RAJ56A	KB.CCN04.110
KEYBOARD	Wireless KB Cocoon Turkey ver. 105 keys(with eKey Vista) RoHS	Y-RAJ56A	KB.CCN04.111
KEYBOARD	Wireless KB Cocoon Hungaria ver. 105 keys(with eKey Vista) RoHS	Y-RAJ56A	KB.CCN04.112
KEYBOARD	Wireless KB Cocoon Greek ver. 104 keys(with eKey Vista) RoHS	Y-RAJ56A	KB.CCN04.113
KEYBOARD	Wireless KB Cocoon Canadian/ French ver. 105 keys(with eKey Vista) RoHS	Y-RAJ56A	KB.CCN04.114
MAINBOARD	MB 946GZ(C2)+ICH7DH RM 1394 ECS	MB 946GZ(C2)+ICH7DH RM 1394 ECS	MB.P3709.020
MEMORY	Samsung DDR2 667 1GB M378T2953EZ3-CE6 Rohs	M378T2953EZ3-CE6	KN.1GB0B.013
MEMORY	"DDRII667 512MB GU34512AJEPN692C4GG, ROHS(NEW PCB)"	GU34512AJEPN692C4GG	KN.5120H.007
MEMORY	Promos DDRII 667 512MB V916764K24QBFW-F5	V916764K24QBFW-F5	KN.5120M.001
MEMORY	UNB-DIMM DDRII 667 512MB NT512T64U88B0BY-3C LF 0.09um	NT512T64U88B0BY-3C	KN.51203.034
MEMORY	"DDRII667 1GB GU341G0AJEPN692C4GG, RoHS(NEW PCB)"	GU341G0AJEPN692C4GG	KN.1GB0H.005
MEMORY	NANYA UNB-DIMM DDRII 667 1GB NT1GT64U8HB0BY-3C LF 0.09um	NT1GT64U8HB0BY-3C	KN.1GB03.017

**Aspire M5600**

<b>CATEGORY</b>	<b>PARTNAME</b>	<b>DESCRIPTION</b>	<b>ACER PART NO.</b>
MEMORY	Hynix DDR2 667 1GB HYMP512U64CP8-Y5 PQ (UDIMM)	HYMP512U64CP8-Y5	KN.1GB0G.007
REMOTE CONTROLLER	SMK VISTA MCE RC - SC EDITION WITH 2 BATTERIES	SMK VISTA MCE RC - SC EDITION WITH 2 BATTERIES	RT.11300.004
REMOTE CONTROLLER	PHILIPS VISTA MCE RC - SC EDITION WITH 2 BATTERIES	PHILIPS VISTA MCE RC - SC EDITION WITH 2 BATTERIES	RT.11300.008
SPEAKER	"JS 2.0 SPEAKER, USB, M- 1118B, ACER LOGO,ROHS"	SPEAKER.1W..2CH.. M1118B..W/ACER LOGO.USB2.0..LEAD -FREE..JAZZ	SP.11805.003
SPEAKER	"LOGITECH 2.0 SPEAKER, S100, 230V WITH EUROPE PLUG TYPE(ROHS)"	S100	SP.S1006.007
SPEAKER	"LOGITECH 2.0 SPEAKER S100 110V W/US PLUG TYPE ACER LOGO, WITH STK LABEL(ROHS)"	S100	SP.S1006.010
POWER SUPPLY	"DELTA 250W DPS-250AB- 22B,NON-PFC"	"DELTA 250W DPS- 250AB-22B,NON- PFC"	PY.25009.001
POWER SUPPLY	DELTA DPS-250AB-22A (PFC) POWER SUPPLY (250W)	DPS-250AB-22A	PY.25009.002
POWER SUPPLY	"FSP 250-50GLV, ROHS 9PA250A007"	FSP 250-50GLV	PY.25008.014

